



FAX Option Type 1232

Operating Instructions Facsimile Reference (option) <Advanced Features>



-
- 1 Transmission Mode
 - 2 Checking and Canceling Transmission Files
 - 3 Communication Information
 - 4 Other Transmission Features
 - 5 Reception Features
 - 6 Simplifying the Operation
 - 7 Facsimile Features
 - 8 Key Operator Setting
 - 9 LAN FAX Features
 - 10 Solving Operation Problems
 - 11 Appendix

For safe and correct use of this machine, please be sure to read the Safety Information in the General Settings Guide before you use it.

Introduction

This manual describes detailed instructions on the operation and notes about the use of this machine. To get maximum versatility from this machine all operators are requested to read this manual carefully and follow the instructions. Please keep this manual in a handy place near the machine.

Notes

Some illustrations in this manual might be slightly different from the machine.

Certain options might not be available in some countries. For details, please contact your local dealer.

Two kinds of size notation are employed in this manual. With this machine refer to the metric version.

Important

Contents of this manual are subject to change without prior notice. In no event will the company be liable for direct, indirect, special, incidental, or consequential damages as a result of handling or operating the machine.

Trademarks

Microsoft®, Windows® and Windows NT® are registered trademarks of Microsoft Corporation in the United States and/or other countries.

Other product names used herein are for identification purposes only and might be trademarks of their respective companies. We disclaim any and all rights in those marks.

Note

The proper names of the Windows operating systems are as follows:

- Microsoft® Windows® 95 operating system
- Microsoft® Windows® 98 operating system
- Microsoft® Windows® Millennium Edition (Windows Me)
- Microsoft® Windows® 2000 Professional
- Microsoft® Windows® XP Professional
- Microsoft® Windows® XP Home Edition
- Microsoft® Windows® 2000 Server
- Microsoft® Windows NT® Server operating system Version 4.0
- Microsoft® Windows NT® Workstation operating system Version 4.0

TABLE OF CONTENTS

How to Read This Manual	1
Symbols	1
Manuals for This Machine	3
Advanced Features (this manual)	3
Basic Features	3

1. Transmission Mode

Extending Function Transmission	5
Sending at a Specific Time (Send Later)	5
Priority Transmission	6
Confidential Transmission	7
Polling Transmission	8
Polling Transmission Clear Report	10
Polling Reception	11
Polling Reserve Report	12
Polling Result Report	12

2. Checking and Canceling Transmission Files

Displaying Confirmation of Transmission	13
Canceling a Transmission	14
Deleting a Destination	14
Adding a Destination	15
Changing the Transmission Time	16
Printing a File	17
Re-sending a File	17
Printing a List of Files in Memory (Print TX File List)	18

3. Communication Information

Printing the Journal	19
Checking the Transmission Result (TX File Status)	21
Checking the Reception Result (RX File Status)	22
Displaying the Memory Status	23
Printing a Confidential Message	24
Confidential File Report	25
Printing a File Received with Memory Lock	26
Personal Boxes	27
Personal Boxes	27
Printing Personal Box Messages	28
Information Boxes	29
Information Boxes	29
Storing Messages in Information Boxes	29
Printing Information Box Messages	30
Deleting Information Box Messages	31

4. Other Transmission Features

Handy Dialing Functions	33
Chain Dial.....	33
Redial.....	33
Advanced Features	35
SUB Code.....	35
SID Code.....	36
SEP Code.....	36
PWD Code.....	37
Transfer Request.....	37
Sub-address.....	39
UUI.....	40
On Hook Dial	41
Manual Dial	42
Changing the Line Type	43
Sub Transmission Mode	45
Book Fax.....	45
2-Sided Transmission (Double-Sided Transmission).....	46
Standard Message Stamp.....	47
Sending an Auto Document.....	47
Printing documents stored as Auto Documents.....	48
Sending a Stored File.....	49
Sending stored documents.....	49
Printing stored documents.....	51
Stamp.....	53
Transmission Options.....	53
Fax Header Print.....	53
Label Insertion.....	54
Sender Stamp.....	54
Reduced Image Transmission.....	54
Auto Reduce.....	54
Default ID Transmission.....	55
Selecting transmission options for a single transmission.....	55
More Transmission Functions	57
If Memory Runs Out While Storing an Original.....	57
Parallel Memory Transmission.....	57
Checking the Transmission Result.....	58
Automatic Redial.....	58
Batch Transmission.....	58
ECM (Error Correction Mode).....	58
Broadcasting Sequence.....	59
Checking the Transmission Progress.....	59
Dual Access.....	59
Transmission with Image Rotation.....	59
Simultaneous Broadcast.....	59
JBIG Transmission.....	60
Printed Report	61
Memory Storage Report.....	61
Transmission Result Report (Memory Transmission).....	61
Communication Failure Report.....	61
Transmission Result Report (Immediate Transmission).....	62

5. Reception Features

Reception	63
Immediate Reception	63
Memory Reception	63
Substitute Reception	64
Receiving messages unconditionally.....	65
Receiving messages according to parameter-specified settings.....	65
Reception Functions	67
Transfer Station.....	67
Transfer Result Report.....	68
JBIG Reception.....	69
Auto Fax Reception Power-up	69
Printing Options	70
Print Completion Beep	70
Checkered Mark.....	70
Center Mark	70
Reception Time	71
2-Sided Printing.....	71
180 Degree Rotation Printing	72
Multi-copy Reception.....	72
Image Rotation.....	72
Combine 2 Originals.....	73
Page Separation and Length Reduction	73
Reverse Order Printing	74
Page Reduction.....	74
TSI Print	75
CIL/TID Print	75
FAX Print Color	75
2nd Color Choice	75
When There is No Paper of the Correct Size.....	76
"Just Size" Printing.....	77
Having Incoming Messages Printed on Paper from the Bypass Tray.....	77
Having Incoming Messages Printed on Paper from the Large Capacity Tray (LCT) ...	78
Where Incoming Messages are Delivered - Output Tray	79
G3/G4 Separate Tray.....	79
Tray Shift.....	79

6. Simplifying the Operation

Programs	81
Registering and Changing Keystroke Programs	81
Using a program	82
Changing a program name.....	83
Deleting a Program	83
Using the Document Server	84
Storing a Document	85
File Manage	87
Delete File.....	88

7. Facsimile Features

Function List	89
Accessing the User Tools	92
Program/Change/Delete Menu	94
Changing the Order of the Quick Dial Table	94
Programming Title of the Quick Dial Table	95
Programming and Changing Standard Messages	96
Deleting Standard Messages	97
Storing and Changing an Auto Document	97
Deleting an Auto Document	99
Programming and Changing a Scan Size	99
Deleting a Scan Size	100
Reports/Lists	101
General Settings/Adjustment	102
Reception Mode	104

8. Key Operator Setting

Function List	107
Using Key Operator Settings	109
Counters	109
Forwarding	109
Programming Forwarding Stations	110
Deleting a Forwarding Station	110
Forwarding Mark	111
Memory Lock	111
ECM	112
Changing the User Parameters	113
Changing the User Parameters	116
Printing the User Parameter List	116
Special Senders to Treat Differently	117
Programming / Changing Special Senders	120
Programming "Initial Set UP" of a Special Sender	121
Deleting a Special Sender	123
Printing the Special Sender List	124
Box Settings	124
Programming/Editing Personal Boxes	124
Deleting Personal Boxes	126
Programming/Editing Information Boxes	126
Deleting Information Boxes	128
Programming/Editing Transfer Boxes	128
Deleting Transfer Boxes	130
Printing the Box List	131
Transfer Report	131
Programming a Confidential ID	132
Programming a Polling ID	133
Programming a Memory Lock ID	133
Selecting Dial/Push Phone	134
Programming ISDN G3 Line	134
Programming ISDN G4 Line	135

9. LAN FAX Features

Sending Fax Documents from PC	137
Installing the Software	138
Auto Run Program	138
Installing the LAN FAX Driver and the Address Book	139
Setting LAN FAX Properties	141
Basic Transmission	142
Printing	143
Address Book.....	143
LAN FAX Operation Messages	144
View Received Messages on a PC	145
Delivering Received Messages	145
Administering the Fax Information on a PC	147
Administer transmission using the LAN FAX driver	147

10.Solving Operation Problems

Reading Reports	149
Error Report	149
Power Failure Report	149
When Toner Runs Out	151

11.Appendix

Replacing the Stamp Cartridge	153
Connecting the Machine to a Telephone Line and Telephone	155
Connecting the Telephone Line	155
Connecting the Machine to ISDN	156
Selecting the Line Type.....	156
Multi-port	157
Optional Equipment	158
Fax Function Upgrade Unit	158
Expansion Memory (32MB: DIMM)	158
ISDN Unit	158
Extra G3 Interface Unit	158
Specifications	159
Acceptable Types of Originals	160
Acceptable Original Sizes	160
Paper Size and Scanned Area	160
Maximum Values	163
INDEX	165

How to Read This Manual

Symbols

In this manual, the following symbols are used:

WARNING:

This symbol indicates a potentially hazardous situation that might result in death or serious injury when you misuse the machine without following the instructions under this symbol. Be sure to read the instructions, all of which are included in “Safety Information” in the General Settings Guide.

CAUTION:

This symbol indicates a potentially hazardous situation that might result in minor or moderate injury or property damage that does not involve personal injury when you misuse the machine without following the instructions under this symbol. Be sure to read the instructions, all of which are included in “Safety Information” in the General Settings Guide.

* The statements above are notes for your safety.

Important

If this instruction is not followed, paper might be misfed, originals might be damaged, or data might be lost. Be sure to read this.

Preparation

This symbol indicates information or preparations required prior to operating.

Note

This symbol indicates precautions for operation, or actions to take after abnormal operation.

Limitation

This symbol indicates numerical limits, functions that cannot be used together, or conditions in which a particular function cannot be used.

Reference

This symbol indicates a reference.

[]

Keys that appear on the machine's panel display.

[]

Keys and buttons that appear on the computer's display.

[]

Keys built into the machine's control panel.

Notice

B4 JIS□□, B5 JIS□□, B6 JIS□ are referred to as B4□□, B5□□, B6□ in this manual.

Manuals for This Machine

There are the Basic Features manual and the Advanced Features manual for this machine. Please consult the manual that suits your needs.

Advanced Features (this manual)

The Advanced Features manual describes more advanced functions and also explains settings for key operators.

Basic Features

The Basic Features manual explains the most frequently used fax functions and operations.

❖ Chapter 1 Getting Started

Describes the parts of the machine and control panel.

❖ Chapter 2 Faxing

Explains about basic transmission. You can also learn about other types of transmissions and how to switch the Reception Modes.

❖ Chapter 3 Registering

Explains how to store, edit and erase names and fax numbers. Quick Dials and Groups are also explained. These functions store numbers and save time when dialing. Also contains information on how to enter letters and symbols.

❖ Chapter 4 Troubleshooting

Explains how to adjust the volume of sounds generated by the machine and how to interpret error messages.

1. Transmission Mode

Extending Function Transmission

To use Extending Function Transmission, follow the directions below. To understand each function, read their operating description.

- 1 Place your original, and then select any scan settings you require.

 **Note**

- It is not necessary to place your original for Polling Reception.

- 2 Press [Transmission Mode].

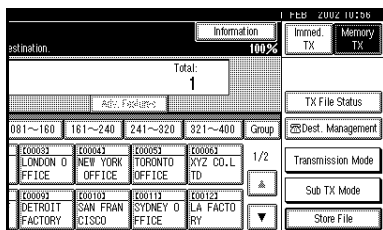

The Extending Function Transmission Mode menu appears.

- 3 Select the function you want to extend and set each function.

- ⇒ p.5 "Sending at a Specific Time (Send Later)"
- ⇒ p.6 "Priority Transmission"
- ⇒ p.7 "Confidential Transmission"
- ⇒ p.8 "Polling Transmission"
- ⇒ p.11 "Polling Reception"

- 4 Specify the destination, and then press the [Start] key.

 **Note**

- It is not necessary to specify the destination for Polling Transmission.

Sending at a Specific Time (Send Later)

Using this function, you can instruct the machine to delay transmission of your fax message until a later time which you specify. This allows you to take advantage of off-peak telephone charges without having to be by the machine at the time.

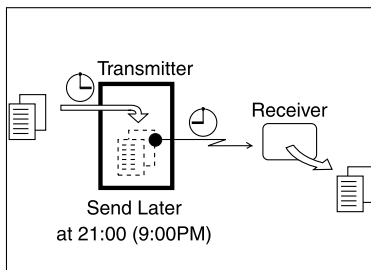

Then if you have a non-urgent fax, just select Send Later with Economy Transmission when you scan it. Faxes will be queued in memory and will be sent during Economy Transmission Time.

 **Note**

- You can specify a time less than 24 hours.
- This function is only available with Memory Transmission.
- If the current time shown on the display is not correct, change it. See "Timer Setting" in the General Settings Guide.
- For convenience, you can program the time when your phone charges become cheaper as the Economy Transmission Time.

Press **[Transmission Mode]** ⇒ **[Send Later]**.

1 Enter the time with the number keys (24 hr format), and press **[OK]**.

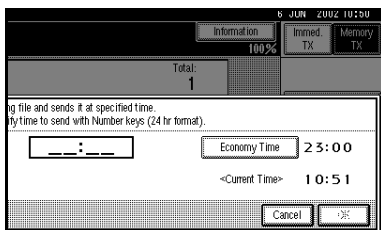

Note

- Press **[Economy Time]** to specify the economy time.
- When entering numbers smaller than 10, add a zero at the beginning.
- If you make a mistake, press **[Clear]** or the **[Clear/Stop]** key and try again.

2 Press **[OK]**.

The initial display is shown.

Note

- To check settings, press **[Transmission Mode]**.
- To cancel Send Later after pressing the **[Start]** key, see p.14 "Canceling a Transmission".

Priority Transmission

Documents you send with Memory Transmission are sent in the order they are scanned. Therefore, if several messages are queued in memory, the next document you send will not be sent immediately. However, by using this function you can have your message sent before any other queued messages.

For Priority Transmission, press **[Transmission Mode]** ⇒ **[Priority TX]**, and then press **[OK]**.

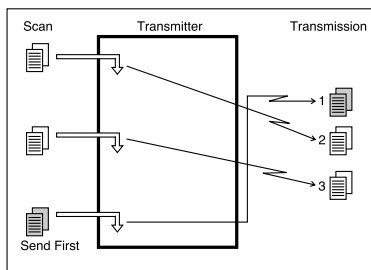

THYS950E

Limitation

- This function is not available with Immediate Transmission. If this function is selected, the machine automatically switches to Memory Transmission.

Note

- If there is already a message stored with this function or a transmission is in progress, your message will be sent after that message has been transmitted.
- Press **[Change/Stop TX File]** after pressing the **[Start]** key to cancel the priority transmission.

Confidential Transmission

If you want to limit into who views your message, use this function. The message will be stored in memory at the other end and will not be printed until an ID is entered.

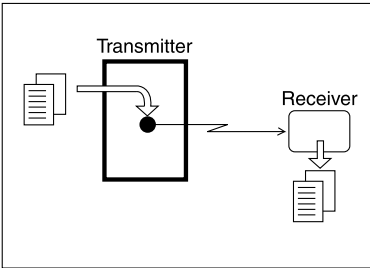

ND1X01E5

There are two types of Confidential Transmission:

◆ Default ID

It is not necessary to enter an ID when transmitting. The other party can print the message by entering the Confidential ID programmed in their machine.

◆ ID Override

Should you wish to send a Confidential Message to a particular person at the other end, you can specify the Confidential ID that person has to enter to see that message. Before you send the message, do not forget to tell the intended receiver the ID that must be entered to print the message.

● Limitation

- The destination machine must be of the same make and have the Confidential Reception function.
- The destination machine must have enough memory available.

✎ Note

- We recommend that you program the Confidential ID beforehand. See p.132 “Programming a Confidential ID”.
- An ID can be any 4 digit number except 0000.
- When the machine is not the same make, you can use Confidential Transmission using “SUB Code”. See p.35 “SUB Code”.

Press **[Transmission Mode]** ⇒ **[Confidential TX]**.

1 Depending on the Confidential Transmission type, use one of the following procedures:

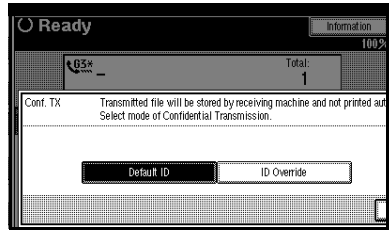

Default ID

- 1 Check **[Default ID]** is selected, and then press **[OK]**.

✎ Note

- If **[Default ID]** is not selected, press **[Default ID]**.

Override ID

- 1 Press **[ID Override]**.

- 2 Enter the Confidential ID (4 digit number) with the number keys, and then press [OK].

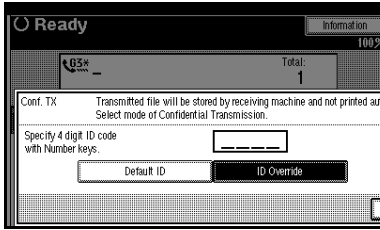

Note

- If you make a mistake, press [Clear] or the [Clear/Stop] key and try again.

- 2 Press [OK].

Note

- To check settings, press [Transmission Mode].
- You can cancel Confidential Transmission after pressing the [Start] key. ⇒ p.14 "Canceling a Transmission".

Polling Transmission

Use Polling Transmission when you want to leave an original in the machine's memory for others to pick up. The message will be sent when the other party calls you up.

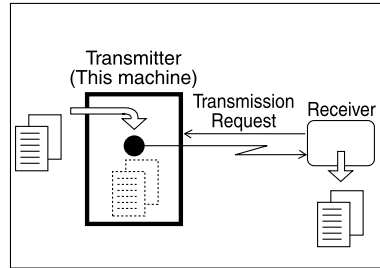

ND1X01E7

There are three types of Polling Transmission.

◆ **Free Polling Transmission**

It is not necessary to enter the Polling ID during the procedure. Anybody can poll the message from your machine. The machine sends it regardless of whether Polling ID's match.

◆ **Default ID Transmission**

It is not necessary to enter the Polling ID during the procedure. The message will only be sent if the Polling ID of the machine trying to poll your message is the same as the Polling ID stored in your machine. Make sure that both machines' Polling IDs are identical in advance.

❖ **ID Override Transmission**

You must enter an Override Polling ID unique to this transmission. This ID overrides that stored in the Polling ID. The user must supply this ID when they poll your machine. If the IDs match, the message is sent. Make sure the other end knows the ID you are using in advance.

! **Limitation**

- ❑ Polling Transmission is allowed only if the receiver's machine has the Polling Reception feature.
- ❑ Usually, only machines of the same make that support Polling Reception can perform ID Polling Transmission. However, when the Information Box File functions is used, and the other party's fax machine supports Polling Transmission and the "SEP" feature, you can still carry out a Polling Transmission with an ID. See p.29 "Information Boxes".

✎ **Note**

- ❑ Free Polling and Default ID Transmission allow only one file to be stored in memory.
- ❑ ID Override Polling Transmission allows a file to be stored in memory for each ID; a total of up to 400 files (800 with the optional Fax Function Upgrade unit) for varying ID's can be stored.
- ❑ Before using "Default ID Transmission", you need to program the Polling ID. See p.133 "Programming a Polling ID".

- ❑ You can set whether a Polling Transmission file is deleted after transmitting in "User Parameters". To save the file to transmit repeatedly, set to "Standby (Save)". See p.113 "Changing the User Parameters" (Switch 11, Bit7).
- ❑ The communication fee is charged to the receiver.

Press **[Transmission Mode]** ⇒ **[Polling TX]**.

1 Depending on the Polling Transmission mode, use one of the following procedures:

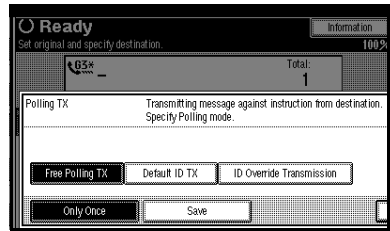

Free Polling TX

- 1** Check that **[Free Polling TX]** is selected.

✎ **Note**

- ❑ If **[Free Polling TX]** is not selected, press **[Free Polling TX]**.

Default ID TX

- 1** Select **[Default ID TX]**.

ID Override Transmission

- 1** Select **[ID Override Transmission]**.

- 2 Specify a 4 digit ID Code with the number keys and [A], [B], [C], [D], [E] and [F].

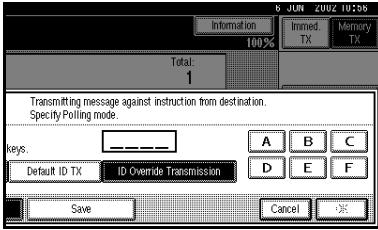

Note

- A Polling ID may be any string of four numbers (0 to 9) and characters (A to F) except 0000 and FFFF.
- If you make a mistake, press **[Clear]** or the **[Clear/Stop]** key and try again.

- 2 Press **[Only Once]** or **[Save]** to delete or save the file after transmission.

Note

- To delete the original immediately after transmission, select **[Only Once]**.
- To repeatedly send the original, select **[Save]**.

- 3 Press **[OK]**.

The Transmission Mode menu is shown.

- 4 Press **[OK]**.

Return to the initial display.

After pressing the **[Start]** key, scanning begins and the originals are stored in memory.

Polling Transmission Clear Report

This report allows you to verify whether Polling Transmission has taken place.

Limitation

- This report is not printed if the User Parameters are set to allow the stored originals to be repeatedly sent (Save). See p.113 "Changing the User Parameters" (Switch11, Bit7).

Note

- You can turn this function on or off with the User Parameters. See p.113 "Changing the User Parameters" (Switch03, Bit6).
- You can set whether a portion of the sent image is printed on the report with the User Parameters. See p.113 "Changing the User Parameters" (Switch04, Bit7).
- You can check the result of Polling Transmission with the Journal.

Polling Reception

Use this function if you want to poll a message from another terminal. You can also poll documents from many terminals with only one operation (use Groups and Keystroke Programs to fully exploit this feature).

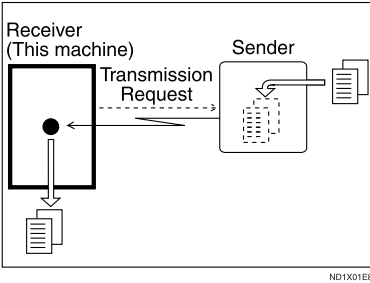

There are two types of Polling Reception.

❖ Default ID/Free Polling Reception

Use this method for Free Polling or Default ID Polling. If the Polling ID is programmed in your machine, any messages waiting in the transmitting machine with the same ID are received. If the other machine does not have any messages waiting with the same Polling ID, any messages that do not require ID are received (Free Polling).

❖ ID Override Polling Reception

You must enter an Override Polling ID unique to this transmission. This ID overrides that stored in the Polling ID.

Your machine will receive any messages waiting in the transmitting machine with matching ID's. If no ID's match, any messages that do not require ID are received (Free Polling).

⚠ Limitation

- Polling Reception requires that the other machine can perform Polling Transmission.
- To receive a message sent by any Default ID Polling Transmission or ID Override Polling Transmission, it is necessary to specify the same Polling ID as the sender's.
- Usually, you can only receive documents with a Polling ID from machines of the same make that support the polling function. However, if the other party's fax machine supports Polling Transmissions and the "SEP" function, and also has stored IDs. You can still perform Polling Reception. See p.36 "SEP Code".
- To receive a message sent by any Free Polling Transmission, it is not necessary to specify the same Polling ID as the sender's.

📝 Note

- For ID Polling Reception, program a Polling ID in advance. See p.133 "Programming a Polling ID".

Press **[Transmission Mode]** ⇒ **[Polling RX]**.

1 Depending on which method you are using, choose one of the following procedures:

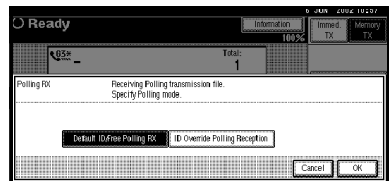

Default ID/Free Polling RX

- 1 Check that **[Default ID/Free Polling RX]** is selected.

 **Note**

- If **[Default ID/Free Polling RX]** is not selected, press **[Default ID/Free Polling RX]**.
-

ID Override Polling Reception

- 1 Press **[ID Override Polling Reception]**.
- 2 Specify a 4 digit ID Code with the number keys and **[A]**, **[B]**, **[C]**, **[D]**, **[E]** and **[F]**.

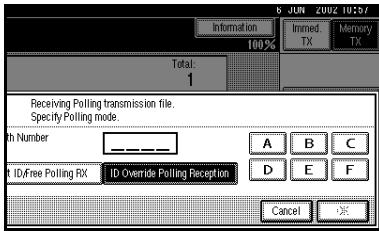

 **Note**

- A Polling ID may be any four numbers (0 to 9) and characters (A to F) except 0000 and FFFF.
- If you make a mistake, press **[Clear]** or the **[Clear/Stop]** key and try again.

- 2 Press **[OK]**.

The Transmission Mode menu is shown.

- 3 Press **[OK]**.

The initial display is shown.

Polling Reserve Report

This report is printed after Polling Reception has been set up.

 **Note**

- You can turn this function on or off with the User Parameters. See p.113 "Changing the User Parameters" (Switch03, Bit3).
-

Polling Result Report

This report is printed after a Polling Reception has been completed and shows its result.

 **Note**

- You can also check the result of a Polling Reception with the Journal. See p.19 "Printing the Journal".
- You can turn this function on or off with the User Parameters. See p.113 "Changing the User Parameters" (Switch03, Bit4).

2. Checking and Canceling Transmission Files

After you have pressed the **[Start]** key (after scanning originals), you can check and edit the destination or settings of Memory Transmission. You can also cancel a transmission, change the settings of a transmission, print a stored file, print a list of stored files and resend a file which failed to transmit.

This function is available for Memory Transmission, Confidential Transmission, Transfer Request, Polling Reception and Polling Transmission.

Note

- There is no file being sent, received or stored by Memory Transmission, if **[Change/Stop TX File]** does not appear on the display.
- You cannot check or edit a file being sent or received. Also a Confidential Transmission file or stored file to be printed as a report cannot be checked or edited.

Displaying Confirmation of Transmission

1 Press **[Change/Stop TX File]**.

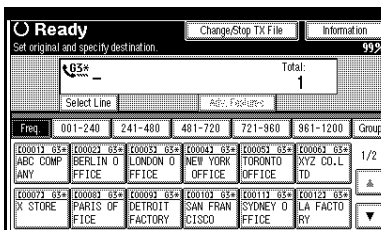

2 Select **[Check/Change Settings]**.

Scanning date/time, transmission mode, destination, total number of destinations, total number of originals, file number and Status are displayed.

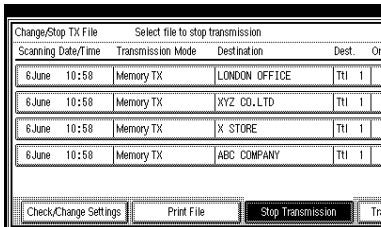

3 Select files to be changed or checked.

Note

- If there are multiple destinations for a file, only the destination selected first is displayed.
- If there are multiple destinations for a file, only the number of destinations that have not been sent the file are displayed.

4 Check a file, and then press **[Exit]**.

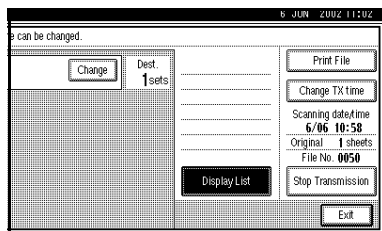

5 Press **[Exit]**.

The initial display is shown.

Canceling a Transmission

You can cancel a transmission of a file when the file is being sent, stored in memory or fails to transmit. All the scanned data is deleted from memory.

You can cancel a file for Memory Transmission. This function is useful to cancel a transmission when you notice a mistake in destination or with the originals after storing originals in memory. To cancel Memory Transmission, search for the file to be canceled among the files stored in memory, and delete it.

 **Note**

- If you cancel a transmission while the file is being sent, some pages of your file may have already been sent and will be received at the other end.
- If the transmission finishes while you are carrying out this procedure, transmission cannot be canceled.

- 1** Press **[Change/Stop TX File]**.
- 2** Select the files whose transmission you want to cancel.

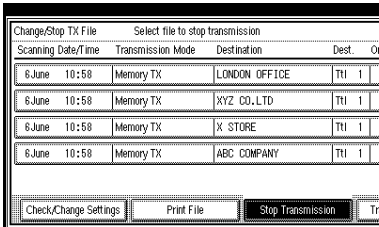

Change/Stop TX File		Select file to stop transmission			
Scanning Date/Time	Transmission Mode	Destination	Dest.	Or	
6 June 10:58	Memory TX	LONDON OFFICE	TRI	1	
6 June 10:58	Memory TX	XYZ CO.,LTD	TRI	1	
6 June 10:58	Memory TX	X STORE	TRI	1	
6 June 10:58	Memory TX	ABC COMPANY	TRI	1	

Check/Change Settings Print File Stop Transmission Tr

 **Note**

- To display only the files being sent, press **[Files under TX]**.
- If there are multiple destinations for a file, only the number of destinations that have not been sent the file are displayed.

- If there are multiple destinations for a file, only one destination can be displayed. To display all destinations, press **[Check/Change Settings]**.

- 3** Press **[Stop Transmission]**.

The file you selected to stop transmitting is deleted.

 **Note**

- To not cancel Transmission, press **[Save]**.
- To cancel another transmission, repeat from step **2**.

- 4** Press **[Exit]**.

The initial display is shown.

Deleting a Destination

You can delete destinations.

 **Note**

- If you delete a destination that is the only destination for a transmission, the transmission is canceled.

- 1** Press **[Change/Stop TX File]**.
- 2** Press **[Check/Change Settings]**.
- 3** Select the file from which you want to delete a destination.

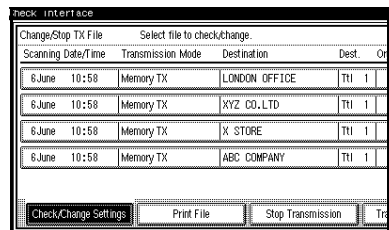

Change/Stop TX File		Select file to check/change			
Scanning Date/Time	Transmission Mode	Destination	Dest.	Or	
6 June 10:58	Memory TX	LONDON OFFICE	TRI	1	
6 June 10:58	Memory TX	XYZ CO.,LTD	TRI	1	
6 June 10:58	Memory TX	X STORE	TRI	1	
6 June 10:58	Memory TX	ABC COMPANY	TRI	1	

Check/Change Settings Print File Stop Transmission Tr

 **Note**

- To display only the files being sent, press **[Files under TX]**.

- 4** Press **[Change]** for the destination you want to delete.

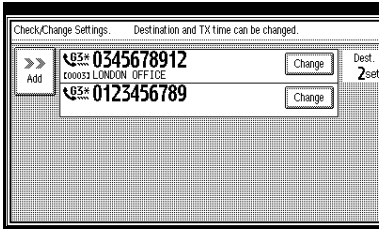

- 5** Press **[Clear]** to delete the destination.

- 6** Press **[Exit]**.

Note

- To delete another destination, repeat from step **5**.

- 7** Press **[Exit]**.

The initial display is shown.

Adding a Destination

- Press **[Change/Stop TX File]**.
- Press **[Check/Change Settings]**.
- Select the file to which you want to add a destination.

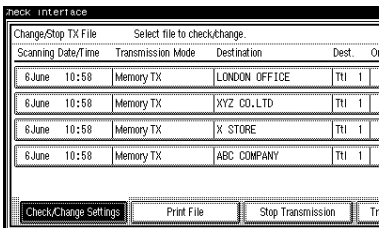

Note

- To display only the files being sent, press **[Files under TX]**.

- 4** Press **[Add]**.

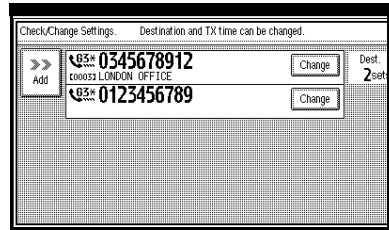

- 5** Specify the destination.

Note

- You can specify the destination using the number keys or software keys.
- You can also program SUB Code and Sub-address by pressing **[Adv. Features]**.

- 6** Press **[Exit]**.

Note

- Repeat steps **4** and **5**, if you want to add another destination.

- 7** Press **[Exit]**.

The initial display is shown.

Changing the Transmission Time

You can change the transmission time which has been specified with Send Later. See p.5 “Sending at a Specific Time (Send Later)”.

You can also delete the transmission time. When the transmission time is deleted, the file is transmitted immediately.

- 1 Press [Change/Stop TX File].
- 2 Press [Check/Change Settings].
- 3 Select the file for which you want to change or cancel the transmission time.

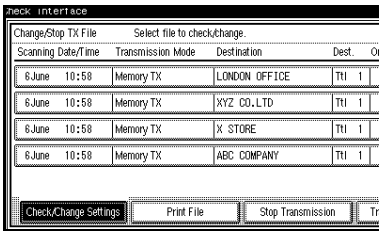

- Note**
- To display only the files being sent, press [Files under TX].

- 4 Press [Change TX time].

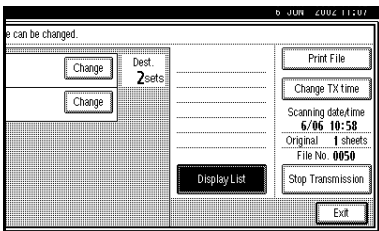

- 5 Press [Clear], and then reenter the transmission time using the number keys or select [Economy Time].

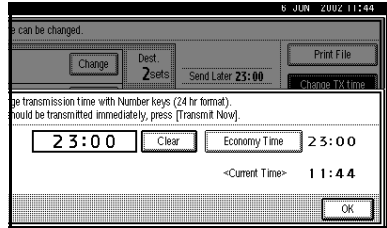

- Note**
- If you select [Economy Time], the economy time already specified is entered. See p.102 “General Settings/Adjustment”.
- If you press [Transmit Now], the file is transmitted immediately. However, if there is a file on standby that file is sent first.

- 6 Press [OK].

- 7 Press [Exit].

- Note**
- Repeat from step 3, if you want to change another transmission time.

- 8 Press [Exit].

The initial display is shown.

Printing a File

If you wish to check the contents of a file that is stored in memory and has not been sent yet, use this procedure to print it out.

Note

- Polling Transmission files are not displayed in the list. Confidential Transmission files are displayed, but cannot be printed.

- 1** Press **[Change/Stop TX File]**.
- 2** Press **[Print File]**.
- 3** Select the file you want to print.

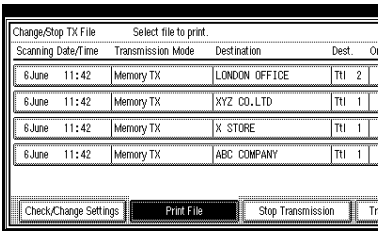

Note

- If there are multiple destinations for a file, only the number of destinations that have not been sent the file are displayed.
- If you want two sided printing (option), press **[Print 2 Sides]**.

- 4** Press the **[Start]** key.

Note

- To cancel a file from printing, press **[Stop Printing]**. The display will return to step **3**.

- 5** Press **[Exit]**.

The initial display is shown.

Note

- Repeat from step **3**, if you want to print another file.

Re-sending a File

This function is valid when the machine is set up with the User Parameters to save messages that could not be sent in memory.

Preparation

You should select "Store for 24 hours" for "Store a message that could not be transmitted" in User Parameters. See p.113 "Changing the User Parameters" (Switch24, Bit0).

Note

- If you select the failed transmission file, you can resend it. This function allows you to transmit a fax message again. These files will be kept for either 24 or 72 hours depending on how you program this function. See p.113 "Changing the User Parameters" (Switch24, Bit1,0).

- 1** Press **[Change/Stop TX File]**.

- 2** Press **[Transmit Failed File]**.

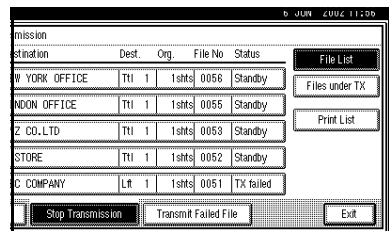

3 Select a file you want to resend.

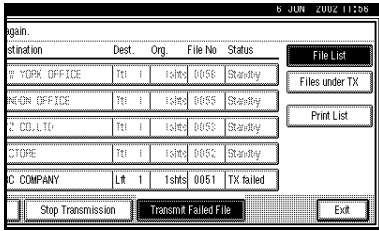

- Note**
- "TX failed" is displayed for files that could not be sent.
- If there are multiple destinations for a file, only the destination selected first is displayed.
- If there are multiple destinations for a file, only the number of destinations that have not been sent the file are displayed.

4 Press [OK].

- Note**
- To add destinations, press [Add] and specify the destinations.
- Repeat from step 3 to resend another file.

5 Press [Exit].

The initial display is shown.
Transmission starts.

Printing a List of Files in Memory (Print TX File List)

Print this list if you wish to find out which files are stored in memory and what their file numbers are. Knowing the file number can be useful (for example when erasing files).

- Note**
- The contents of a file stored in memory can also be printed. See p.17 "Printing a File".

1 Press [Change/Stop TX File].

2 Press [Print List].

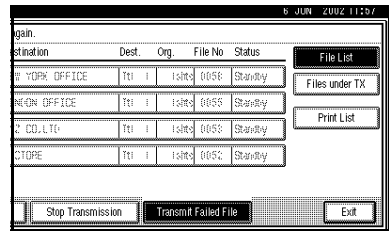

3 Press the [Start] key.

- Note**
- To cancel printing, press [Stop Printing]. The display will return to step 2.

4 Press [Exit].

The initial display is shown.

3. Communication Information

Printing the Journal

The Journal contains information about maximum of the last 50 communications made by your machine. It is printed automatically after every 50 communications (receptions+transmissions).

If the machine is installed with the optional ISDN Unit or the optional Extra G3 Interface Unit, you can print the Journal of each line type.

You can also print a copy of the Journal at any time by following the procedure below.

Important

The contents of a Journal printed automatically are deleted after printing. If you administer the history of transmissions and receptions, we recommend that you keep the Journal. You can check a total of 200 communications (1,000 with the optional Fax Function Upgrade unit) (receptions+transmissions) on the display.

◆ All

Prints the results of communications in the order made.

◆ Print per File No.

Prints only the results of communications specified by file number.

◆ Print per User Code

Prints only the results of communications for a specified User Code. See p.9 "Reading the Display Panel and Using Keys", *Facsimile Reference (option) <Basic Features>*.

Note

- ❑ The sender's name column of the Journal is useful when you need to program a special sender. See p.117 "Special Senders to Treat Differently".
- ❑ If you do not want the Journal printed, you can turn it off. See p.113 "Changing the User Parameters" (Switch03, Bit7).
- ❑ You can set whether the Journal is automatically printed after every 50 communications in User Parameters. See p.113 "Changing the User Parameters" (Switch03, Bit7).
- ❑ You can set whether you print the Journal by line type. See p.113 "Changing the User Parameters" (Switch19, Bit1).

Press **[Information]** ⇒ **[Print Journal]**.

1 Select a printing mode.

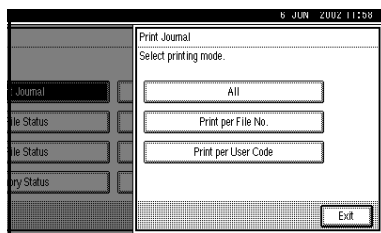

Selecting **[All]**

1 Press **[All]**.

Selecting [Print per File No.]

- 1 Press [Print per File No.].
- 2 Enter a 4 digit file number.

 **Note**

- If you make a mistake, press [Clear] or the [Clear/Stop] key and try again.

Selecting [Print per User Code]

- 1 Press [Print per User Code].
- 2 Specify an 8 digit User Code with the number keys.

 **Note**

- If you make a mistake, press [Clear] or the [Clear/Stop] key and try again.

- 3 Press [⊕].
- 4 Check the User Code shown on the display.

- 2 Press the [Start] key.

 **Note**

- To cancel a file printing, press [Stop Printing] and the display will return to step 1.

- 3 Press [Exit].

Return to the initial display.

Checking the Transmission Result (TX File Status)

You can browse a part of the Transmission Result Report on the display.

Note

- Only the transmission result of the last 200 communications are shown.
- If a transmission is completed while you are using this function, the result will not be shown until you exit TX File Status and start it again.

Press **[Information]** ⇒ **[TX File Status]**.

1 Check the transmission results.

TX File Status		Displaying transmission file status.	
Date/Time	Destination	Original C	
10 June 6:55	ABC COMPANY	1	
10 June 6:54	ABC COMPANY	1	
10 June 6:54	ABC COMPANY	1	
10 June 6:33	ABC COMPANY	1	
9 June 14:12	ABC COMPANY	1	
9 June 12:48	ABC COMPANY	1	

Transmission results are displayed from the latest result in groups of six.

Scanning date/time, destination, originals quantity, file number and status are displayed.

Note

- "Destination" shows the Own Fax Number or Fax Header information of a receiver. For a transmission from a computer, "-- LANFAX -->" is shown.

2 Press **[Exit]**.

Return to the initial display.

Checking the Reception Result (RX File Status)

You can browse a part of the Reception Result Report on the display.

Note

- Only the reception result of the last 200 communications are shown.
- If a message is received while you are using this function, the result will not be shown until you exit RX File Status and start it again.

Press **[Information]** ⇒ **[RX File Status]**.

1 Check the reception results.

RX File Status		Displaying reception file status.	
Date/Time	TX Station	Original C	
10 June 7:22	ABC COMPANY		2
10 June 6:58	ABC COMPANY		4
10 June 6:57	ABC COMPANY		1
9 June 12:52	ABC COMPANY		1
9 June 12:50	ABC COMPANY		1
9 June 7:49	ABC COMPANY		1

Reception results are displayed from the latest result in groups of six.

Scanning date/time, Transmission Station, originals quantity, file number and Status are displayed.

Note

- TX Station shows the fax number of a sender or Fax Header information.

2 Press **[Exit]**.

Return to the initial display.

Displaying the Memory Status

Use this function to display a summary of current memory usage. Items shown are the percentage of free memory space, the percentage of received Confidential Messages, the number of files to be sent, the number of Memory Lock files and the number of received messages to be printed.

Press **[Information]** ⇒ **[Memory Status]**.

1 Check the memory status.

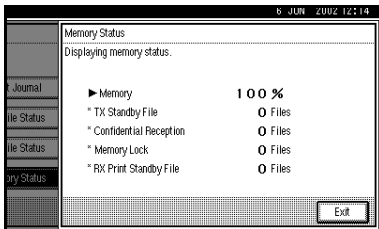

Note

- "Others" will be displayed:
 - When storing attachment files. See p.97 "Storing and Changing an Auto Document".
 - When storing Transfer Request files. See p.37 "Transfer Request".
 - When storing originals in the Information Boxes. See p.29 "Information Boxes".
 - When sending to the Personal Box. See p.27 "Personal Boxes".

2 Press [Exit].

Return to the initial display.

Printing a Confidential Message

This function is designed to prevent unauthorized users from reading your messages. If someone sends you a message using Confidential Transmission, it is stored in memory and not automatically printed. To print the message you have to enter the Confidential ID Code. When your machine has received a Confidential Message, the **Confidential File** (🔒) indicator lights.

📄 Preparation

Before using this function, program your Confidential ID. See p.132 “Programming a Confidential ID”.

⚠️ Important

- ❑ If the main power switch is off more than 1 hour, all Confidential Messages are deleted. In that case, use the Power Failure Report to identify which messages have been deleted. See p.149 “Power Failure Report”.

💡 Limitation

- ❑ You must program the Confidential ID for Confidential Reception to work.

Confirm that the Confidential File indicator is lit, and then press **[Information]** ⇒ **[Print Confidential RX File]**.

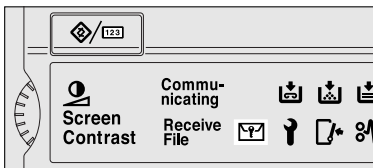

ZGRS020A

📝 Note

- ❑ If the machine received a message with SUB Code, the Confidential File indicator also lights.
- ❑ Print a message with SUB Code using the **[Print Personal Box File]** function. See p.28 “Printing Personal Box Messages”.
- ❑ If no Confidential Messages have been received, the message “No reception file.” is shown. Press **[Exit]**.

1 Enter a 4 digit Confidential ID with number keys.

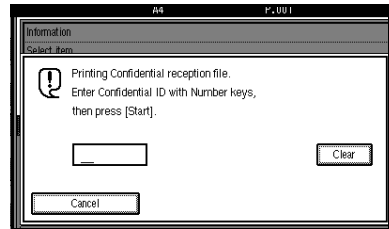

The Confidential ID is not shown on the display.

📝 Note

- ❑ You must enter the Confidential ID programmed in this machine when the received file has no Confidential ID.
- ❑ You must enter the Confidential ID programmed by the sender. Confirm the sender's Confidential ID in advance.

- ❑ If the Confidential IDs or Personal Confidential IDs do not match, the message “No reception file under specified Confidential ID.” is displayed. Press **[Exit]** to cancel the operation, and then check the Confidential ID or Personal Confidential ID with the other party and try again.

2 Press the **[Start]** key.

Return to the initial display.

If you cannot print confidential files even if the Confidential File (CF) indicator is lit.

The Confidential File indicator also lights if the machine received a message with a SUB Code. Check the Personal Boxes.

Note

- ❑ Print from the Personal Box, when a file has been sent from another party with a SUB Code attached. See p.27 “Personal Boxes”.

Confidential File Report

When this function is turned on, this report is printed whenever your machine receives a Confidential Message.

Note

- ❑ You can turn this function on or off with the User Parameters. See p.113 “Changing the User Parameters” (Switch04, Bit0).

Printing a File Received with Memory Lock

This is a security function designed to prevent unauthorized users from reading your messages. If Memory Lock is switched on, all received messages are stored in memory and are not automatically printed. To print the messages, you have to enter the Memory Lock ID Code. When your machine has received a message with Memory Lock, the **Confidential File** (🔒) indicator blinks.

Preparation

Before using this function, program your Memory Lock ID. See p.133 "Programming a Memory Lock ID".

Before using this function, set Confidential Transmissions to On.

Important

- ❑ If the main power switch is turned off for more than an hour, all messages protected by Memory Lock will be deleted. In that case, the Power Failure Report will be printed so you can confirm which messages have been deleted. See p.149 "Power Failure Report".

Note

- ❑ If free memory space is low, messages may not be received.
- ❑ You can also apply a Memory Lock to messages that come only from certain senders. See p.117 "Special Senders to Treat Differently".
- ❑ Messages received by Polling Reception are automatically printed even if this function is switched on.

Confirm that the Confidential File indicator is lit, and press **[Information]** ⇒ **[Print Memory Lock]**.

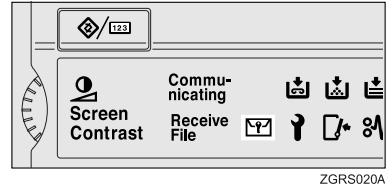

ZGRS020A

Note

- ❑ If no messages were received while Memory Lock was switched on, the message "No reception file." is shown. Press **[Exit]**

1 Enter a 4 digit Memory Lock ID with the number keys.

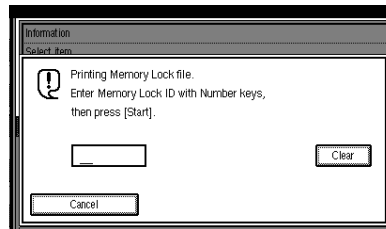

The Memory Lock ID is not shown on the display.

Note

- ❑ If the Memory Lock ID does not match, the message "Specified code does not correspond to programed Memory Lock ID." is shown. Press **[Exit]** and retry after checking the Memory Lock ID.

2 Press the **[Start]** key.

When the printing is completed, return to the initial display.

Personal Boxes

Personal Boxes

This function lets you set up the machine so that incoming messages addressed to certain users are stored in memory instead of being printed out immediately. Each user must be assigned a SUB Code (Personal Code) that has been designated as a Personal Box beforehand. When the other party sends their message, they specify the SUB Code of the user to which they are sending the message. When the message is received, it is stored in the Personal Box with the matching SUB Code. In order to print a message received into a Personal Box, you must enter the SUB Code assigned to that Personal Box. This enables several individuals or departments to share a single fax machine yet be able to differentiate between messages. Furthermore, if you specify a receiver for the Personal Box, instead of being stored in memory, incoming messages with this SUB Code appended are forwarded directly to the destination you specify.

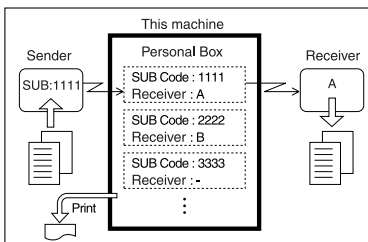

Note

- ❑ To be able to receive messages into a Personal Box you must inform the sender of the SUB Code registered for that Personal Box and ask them to send the message using SUB Code Transmission with that SUB Code. See p.35 "SUB Code".
- ❑ When messages have been received into Personal Boxes, the Confidential Reception/Memory Lock indicator lights and the Confidential File Report is printed. See p.25 "Confidential File Report".
- ❑ If a Personal Box is assigned a receiver, incoming messages are transferred to that receiver with a Forwarding Mark stamped on them. See p.109 "Forwarding".
- ❑ If a receiver is not assigned, print these messages. See p.28 "Printing Personal Box Messages".

Printing Personal Box Messages

Follow these steps to print a message that has been received into a Personal Box.

Preparation

Before using this function, set the Personal Box in advance. See p.124 “Programming/Editing Personal Boxes”.

Note

- If you print a Personal Box message, it is deleted.

Press **[Information]** ⇒ **[Print Personal Box File]**.

- 1** Select the box with the message you want to print.

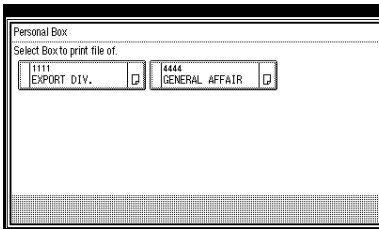

When a password is required

The screen is displayed, when the selected Personal Box password is set in advance. The password is registered in “Key Operator Tools”. See p.124 “Programming/Editing Personal Boxes”.

- 1** Enter the password, and then press **[OK]**.

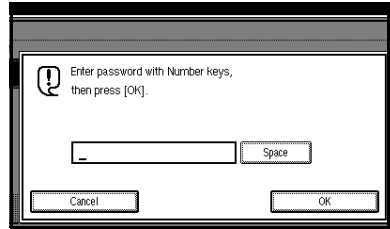

Note

- If you make a mistake, press **[Clear]** or the **[Clear/Stop]** key and try again.

- 2** Press the **[Start]** key.

The received messages are printed.

Note

- To stop printing, press **[Stop Printing]**. The display will return to step **1**.

- 3** Press **[Exit]**.

Return to the initial display.

Note

- If there are messages in other Personal Boxes, the display will return to step **1**. Repeat from step **1** to print another file.

Information Boxes

Information Boxes

Use the Information Box function to set up the machine as a Fax Information service or Document Server. By scanning documents into Information Boxes, other parties can receive these messages whenever they request them.

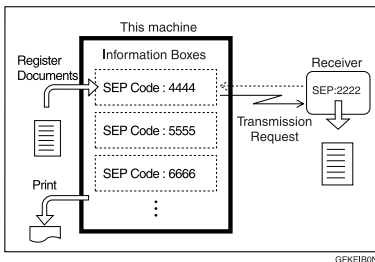

- You can program documents for this function with “Storing Messages in Information Boxes”. See p.29 “Storing Messages in Information Boxes”.
- For other parties to be able to retrieve a message programmed in an Information Box, you need to inform them of the SEP Code assigned to that Information Box.
- When a SEP Code Polling Reception request is made by another party, the SEP Code they specify is compared with the SEP Codes programmed in that Information Boxes. If a code matches, the message stored in the Information Box is sent to the other party automatically.
- You can check on the contents of Information Boxes with “Printing Information Box Messages”. See p.30 “Printing Information Box Messages”.

- You can set a password for Information Boxes in advance. A password can be set in “Key Operator Setting”. See p.126 “Programming/Editing Information Boxes”.

Storing Messages in Information Boxes

Follow these steps to store a message in an Information Box.

Preparation

Before using this function, set the Information Box in advance. See p.126 “Programming/Editing Information Boxes”.

Note

- One Information Box stores one file.
- The stored file is not deleted automatically. If you want to delete a stored file, see p.31 “Deleting Information Box Messages”.

Press **[Information]** ⇒ **[Store/Delete/Print Information Box File.]**.

- 1** Select the box in which you want to store the file.

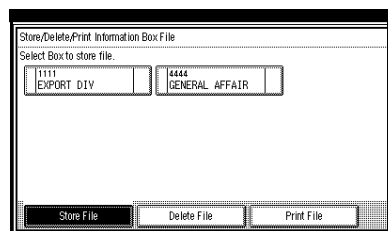

Note

- When there are pre-registered files, a file mark is displayed at the end of the Box Name.

- A message is displayed, when selecting a box with a file stored in it. Press **[Register]**, when changing the file name. The originally stored file will be overwritten.
- If the password is already set, enter it into the Confirmation Display.

2 Place the original, and then select any scan settings you require.



Note

- You can also select the following settings.
 - Book Fax
 - 2 Sided Original (Optional Document Feeder (ADF) is required)
 - Stamp (Optional Document Feeder (ADF) is required)

3 Press the **[Start]** key.

The machine starts to scan the original.

To stop scanning, press **[Stop Scanning]**. The display will return to step 1.

4 Press **[Exit]**.

Return to the initial display.

Note

- To store a message in another Information Box continuously, return to step 1.

Printing Information Box Messages

Follow these steps to print the message stored in an Information Box.

Press **[Information]** ⇒ **[Store/Delete/Print Information Box File]**.

1 Press **[Print File]**, and select the box that contains the stored file you want to print.

The SEP Code and Box Name are displayed.

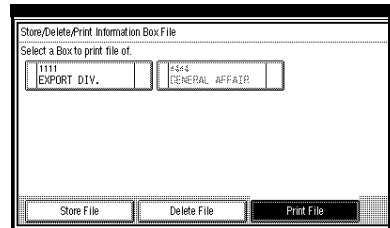

Note

- You cannot select a box which has no stored file.
- If the password is already set, enter it into the Confirmation Display.

2 Press the **[Start]** key.

The machine starts to print.

Note

- If you want 2 sided printing (option), press **[Print 2 Sides]** before pressing the **[Start]** key.
- To stop printing, press **[Cancel]** and the display will return to step 1.
- To stop printing, press **[Stop Printing]** and the display will return to step 1.

3 Press **[Exit]**.

Return to the initial display.

Note

- Repeat from step **1** to print another stored file in the box.

Deleting Information Box Messages

Follow these steps to delete a file stored in an Information Box.

Press **[Information]** ⇒ **[Store/Delete/Print Information Box File]**.

1 Press **[Delete File]**, and select the box that contains the stored file you want to delete.

The SEP Code and Box Name are displayed.

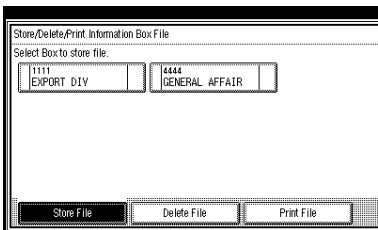
**Note**

- You cannot select a box which has no stored file.
- If the password is already set, enter it into the Confirmation Display.

2 Press the **[Start]** key.

The machine starts to print.

Note

- If you want 2 sided printing (option), press **[Print 2 Sides]** before pressing the **[Start]** key.
- To stop printing, press **[Stop Printing]** and the display will return to step **1**.

3 Press **[Exit]**.

Return to the initial display.

Note

- Repeat from step **1** to delete another stored file in another box.

3

4. Other Transmission Features

Handy Dialing Functions

Chain Dial

This allows you to compose a telephone number from various parts, some of which may be stored in Quick Dials and some of which may be entered using the number keys.

Note

- Maximum length of a telephone or fax number: 254 digits
- For Memory Transmission and Immediate Transmission, insert a pause between parts of a number. For On Hook Dial and Manual Dial, no pause is needed.

(Example) 01133-1-555333

Assume that 01133 is stored in Quick Dial key.

- ① Place the original, and then select any scan settings you require.
- ② Press the Quick Dial key which is programmed "01133".
- ③ Press the **【Pause/Redial】** key.
- ④ Enter **【1】**, **【5】**, **【5】**, **【5】**, **【3】**, **【3】**, **【3】** with the number keys.
- ⑤ Press the **【Start】** key.

Redial

The machine memorizes the last 10 destinations that have been dialed. If you wish to send a message to a destination which you sent faxes recently, the Redial function saves you time by finding and entering the number again.

Limitation

- The following kinds of destinations are not memorized:
 - Quick Dials
 - Group Dials
 - Destinations dialed by a Program
 - Destinations dialed as End Receivers for Transfer Request
 - Forwarding terminal of the Substitute Reception
 - Destinations dialed using the external telephone
 - Destinations dialed by Redial (regarded as already stored in memory)
 - Second and later destinations broadcasted
- Do not dial any numbers before you press the **【Pause/Redial】** key. If you press the **【Pause/Redial】** key after entering numbers using the number keys, a pause will be entered instead.

1 Press the **[Pause/Redial]** key.

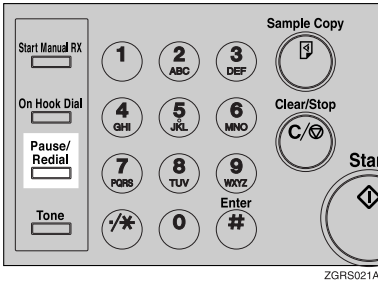

ZGRS021A

4

2 Select a destination you want to redial.

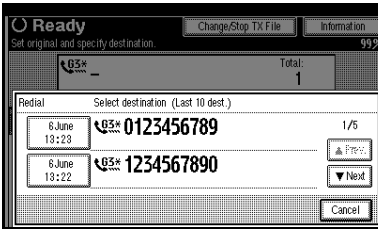

Note

- As the date and time of the reading of the original has become a key, select it by pressing on it.
- If the receiver uses a fax machine of the same manufacturer that is capable of programming the Own Name, that name may be shown on the display instead of the fax number. See p.37 “Initial Settings and Adjustments”, *Facsimile Reference (option) <Basic Features>*.

Advanced Features

SUB Code

Normally you can only use Confidential Transmission to send messages to fax machines of the same make that have the Confidential Reception function. See p.7 “Confidential Transmission”. However, if the other machine supports a similar function called “SUB Code”, you can send fax messages to the other party using this method instead.

Limitation

- You cannot use this function with G4.

Note

- The ID can be up to 20 digits long and consist of numbers, spaces, * and #.
- You can store IDs in Quick Dials, Groups and Programs. See p.81 “Registering and Changing Key-stroke Programs”. See p.40 “Quick Dial”, *Facsimile Reference (option)* <Basic Features>. See p.44 “Groups”, *Facsimile Reference (option)* <Basic Features>.
- You cannot select this function when carrying out standard Confidential Transmission.

Dial the facsimile number using the number keys, and then press **[Adv. Features]** ⇒ **[SUB Code]**.

- 1** Press **[TX SUB Code]**.

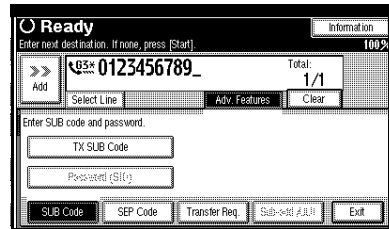

- 2** Enter a SUB Code with the number keys, and then press **[OK]**.

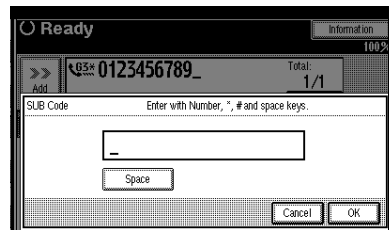

Note

- If you make a mistake, press **[Cancel]** or the **[Clear/Stop]** key and try again.

- 3** To enter a password, press **[Password (SID)]**.

- 4** Enter the password with the number keys, and then press **[OK]**.

- 5** Press **[Exit]**.

Note

- If you use Immediate Transmission and the destination fax machine does not support the SUB Code function, a message will appear on the display to inform you of this. In this case, press **[OK]** to cancel the transmission.

SID Code

There are times when you may wish to use a "SID" (Sender ID) when sending confidential faxes with the SUB Code function.

Note

- ❑ You can enter a SID using up to 20 digits.
- ❑ You can store IDs in Quick Dials, Groups and Programs. See p.81 "Registering and Changing Keystroke Programs". See p.40 "Quick Dial", *Facsimile Reference (option)* <Basic Features>. See p.44 "Groups", *Facsimile Reference (option)* <Basic Features>.

SEP Code

Normally you can only use Polling Reception to receive faxes from machines that have the Polling Reception function of the same make. However, if a machine of another make supports a Polling Reception, you can receive fax messages from the other party using this method instead.

Poll the other machine. You can receive messages that have the same SEP Code as the SEP Code you entered.

Limitation

- ❑ You cannot use this function with G4.

Note

- ❑ The ID can be up to 20 digits long.

- ❑ You can store IDs in Quick Dials, Groups and Programs with the number keys, and consist of space, * and #. See p.40 "Quick Dial", *Facsimile Reference (option)* <Basic Features>. See p.44 "Groups", *Facsimile Reference (option)* <Basic Features>. See p.81 "Registering and Changing Keystroke Programs".

Dial the facsimile number using the number keys, and then press **[Adv. Features]** ⇒ **[SEP Code]**.

- 1** Press **[RX SEP Code]**.

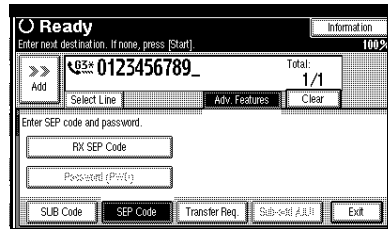

- 2** Enter a SUB Code with the number keys, and then press **[OK]**.

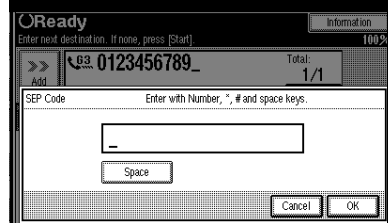

Note

- ❑ If you make a mistake, press **[Cancel]** or the **[Clear/Stop]** key and try again.

- 3** To enter a password, press **[Password (PWD)]**.

- 4** Enter the password with the number keys, and then press **[OK]**.

- 5** Press **[Exit]**.

6 Press [Transmission Mode].

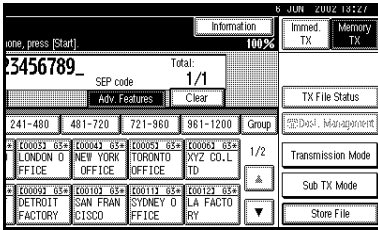

7 Select [Polling RX].

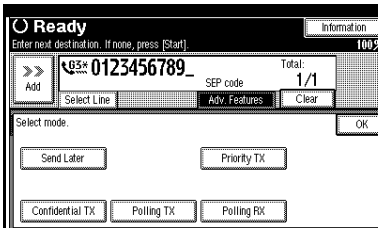

8 Press [Default ID/Free Polling RX] and [OK].

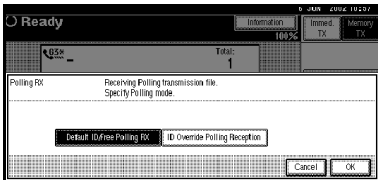

Note

- To cancel Polling RX, press **[Cancel]**. The display will return to step 7.

9 Press [OK].

The initial display is shown.

If you press the **[Start]** key, Polling Reception will start.

PWD Code

There are times you may wish to use a password when receiving faxes by polling with the SEP Code function.

Note

- You can enter a password up to 20 digits long.
- You can store IDs in Quick Dials, Groups and Programs. See p.40 "Quick Dial", *Facsimile Reference (option)* <Basic Features>. See p.44 "Groups", *Facsimile Reference (option)* <Basic Features>. See p.81 "Registering and Changing Key-stroke Programs".

Transfer Request

Transfer Request allows fax machines that have this function to automatically distribute incoming messages to multiple fax destinations. This function helps you save costs when you send the same message to more than one place in a distant area, and saves time since many messages can be sent in a single operation.

The diagram below may make the concept clearer.

The Transfer Stations you specify must be machines of the same make as this machine and have the Transfer Station function.

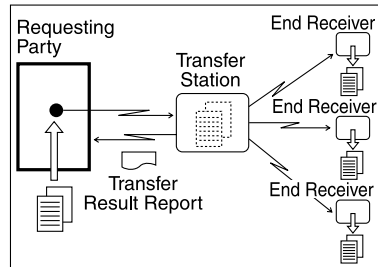

ND1X01E9

The following terminology is used in this section.

◆ Requesting Party

The machine where the message originates from.

◆ Transfer Station

The machine that forwards the incoming message to another destination.

◆ End Receiver

The final destination of the message or the machine to which the Transfer Station sends to. End Receivers must be programmed into Quick Dials or Groups in the Transfer Station.

📄 Preparation

Before you can use this function, you must program the Polling ID and your own fax number. See p.133 “Programming a Polling ID”, p.131 “Transfer Report”.

💡 Limitation

- ❑ The Transfer Stations you specify must be machines of the same make as this machine and have the Transfer Station function.
- ❑ You cannot use Transfer Request without programming the fax number of the Requesting Party in Quick Dial or Speed Dial.

📌 Note

- ❑ Polling ID's of the Requesting Party (this machine) and Transfer Stations must be identical.
- ❑ You can specify up to 500 Transfer Stations in a Transfer Request. However, you can only specify up to 50 Transfer Stations from the number keys.

- ❑ You can have up to 30 End Receivers per Transfer Station. If you specify a Transfer Station Group, the Group counts as a single receiver.
- ❑ The combined total of End Receivers and Transfer Stations you specify with the number keys cannot exceed 100. See p.31 “Number Keys”, *Facsimile Reference (option) <Basic Features>*.

Specify the Transfer Station with either Quick Dials or the number keys, and then press **[Adv. Features]** ⇒ **[Transfer Req.]**.

1 Press [Receiving Station].

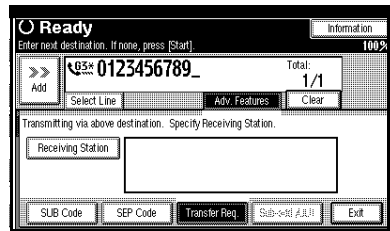

2 Dial an End Receiver.

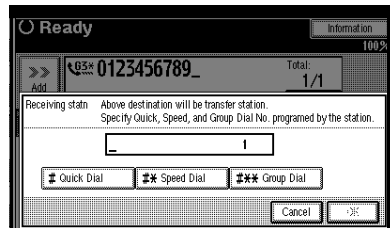

📌 Note

- ❑ You cannot enter the numbers of the End Receivers directly. The numbers must be stored in Quick Dials or Groups in the Transfer Station(s). To specify an End Receiver, use the special format described below.
- ❑ To cancel the Transfer Request, press **[Cancel]**.

Quick Dial

- ❶ Press [**#** Quick Dial].
- ❷ Enter the number (2 or 3 digits) of the Quick Dial where the End Receiver is stored.

For example, to choose the number stored in Quick Dial 01 in the Transfer Station, enter: **[0][1]**.

Speed Dial

- ❶ Press [**#* Speed Dial**].
- ❷ Enter the number (2 or 3 digits) of the Speed Dial code.

For example, to choose the number stored in Speed Dial 12 in the Transfer Station, enter: **[1][2]**.

Group Dial

- ❶ Press [**#** Group Dial**].
- ❷ Enter the number (2 digits) of the Group number.

For example, to choose the number stored in Group Dial 04 in the Transfer station, enter: **[0][4]**.

To cancel the Transfer Request, press [**Cancel**].

- ❸ Press [**Add**].

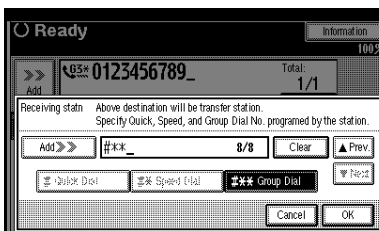

Repeat step ❷ to enter more End Receivers.

Note

- Press [**▲ Prev.**] or [**▼ Next**] to see the End Receivers already entered. You can select an End Receiver from this list and remove it by pressing [**Clear**] or the [**Clear/Stop**] key.
- When you have specified all the End Receivers, go to step ❸.

- ❹ Press [**OK**].

- ❺ Press [**Exit**].

Note

- The Transfer Stations and End Receivers are displayed.

Sub-address

The optional ISDN Unit is required.

ISDN allows two or more terminals (such as a fax machine and digital telephone) to be connected to a single line. These terminals are identified by their sub-address numbers. If the terminals connected to the line at a destination are assigned sub-addresses, dialing a sub-address allows you to direct your fax message to a particular terminal at the destination.

Limitation

- Sub-addresses can only be used with ISDN.

Note

- You can program a sub-address in Quick Dial.

To send using Sub-address, first, select either G4 or G3 (ISDN). Second, dial the fax number with the number keys and then press **[Adv. Features]** ⇒ **[Sub-add./UII]**.

Note

- When the optional ISDN Unit is installed, the line used for G3 is set to ISDN.

Reference

See p.43 “Changing the Line Type”.

1 Select **[Sub-address]**.

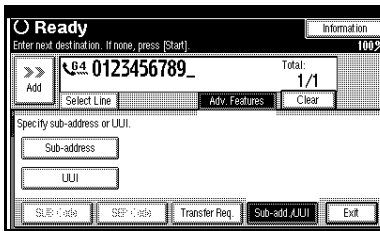

2 Enter the destination sub-address with the number keys, and then press **[OK]**.

Note

- If you make a mistake, press **[Clear]** or the **[Clear/Stop]** key and try again.

3 Press **[Exit]**.

UII

The optional ISDN Unit is required.

Limitation

- UII can only be used with ISDN.

Note

- You can program a UII in Quick Dial.

To send using UII, first, select either G4 or G3 (ISDN). Second, dial the fax number with the number keys and then press **[Adv. Features]** ⇒ **[Sub-add./UII]**.

Note

- When the optional ISDN Unit is installed, the line used for G3 is set to ISDN.

1 Select **[UII]**.

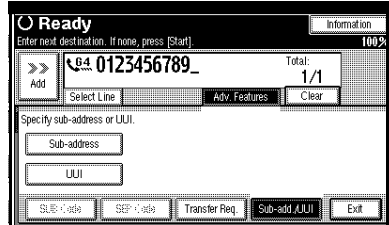

2 Enter the destination UII with the number keys, and then press **[OK]**.

Note

- If you make a mistake, press **[Clear]** or the **[Clear/Stop]** key and try again.

3 Press **[Exit]**.

On Hook Dial

This is just like using the external telephone, except you do not have to pick up the external telephone before dialing. Just press the **[On Hook Dial]** key and dial the number. If you hear a voice, you can pick up the external telephone and speak with the other party.

Limitation

- This function is not available for the optional Extra G3 Interface Unit.

Note

- This function is not available in some countries.
- On Hook Dial does not work with ISDN lines.

1 Place your original, and then select any scan settings you require.

2 Press the **[On Hook Dial]** key.

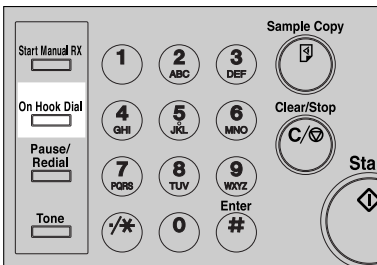

You will hear a low tone from the internal speaker. If you wish to cancel this operation, press the **[On Hook Dial]** key again.

3 Dial.

The machine immediately dials the destination.

Note

- You can adjust the volume of On-hook sound by pressing **[Higher]** or **[Lower]** in the upper right-hand corner of the screen. The volume can also be preprogrammed in "Initial Settings and Adjustments". See p.51 "Adjusting Volume", *Facsimile Reference (option) <Basic Features>*.
- If you make a mistake, press the **[On Hook Dial]** or **[Clear Modes]** key and return to step 2.

4 When the line is connected and you hear a high-pitched tone, press the **[Start]** key.

Note

- If you hear a voice, pick up the external telephone before you press the **[Start]** key and notify the destination that you want to send a fax message (ask them to switch to Facsimile mode).
- After transmission, the machine will return to standby mode.
- If you want to cancel a transmission, press the **[Clear/Stop]** key and remove the originals.

Manual Dial

The external telephone is required.

Pick up the handset of the external telephone and dial. When the line is connected and you hear a high-pitched tone, press the **[Start]** key to send your fax message. If, on the other hand, you hear a voice at the other end, continue your conversation as you would normally over the telephone.

4

Limitation

- Manual Dial does not work with ISDN lines.
- This function is not available for the optional Extra G3 Interface Unit.
- The result of a transmission with Manual Dial is not mentioned in the Transmission Result Report (Immediate Transmission).
- Set originals on the exposure glass. The optional Document Feeder (ADF) cannot be used.

1 Place your original, and then select any scan settings you require.

2 Pick up the external telephone.

You will hear a tone.

3 Dial.

The machine immediately dials the destination.

Note

- If you make a mistake, replace the external telephone and try again from step **2**.

4 When the line is connected and you hear a high-pitched tone, press the **[Start]** key to send your fax message.

Note

- If you hear a voice, notify the destination that you want to send a fax message (ask them to switch to Facsimile mode).

5 Replace the handset of the external telephone.

After transmission, the machine will return to standby mode.

Note

- If you want to cancel transmission, press the **[Clear/Stop]** key and remove the originals.

Changing the Line Type

The optional ISDN Unit or Extra G3 Interface Unit is required.

When the optional ISDN Unit and Extra G3 Interface Unit are installed, you can connect to up to a maximum of 3 lines.

Note

- When you install the optional ISDN Unit or Extra G3 Interface Unit, you can specify the line type home position from “Gen. Settings/Adjust”. See p.102 “General Settings/Adjustment”.
- When sending a fax, you can select the line type if dialing with the number keys or Chain Dial.

G3

G3 is selected after power up or when the machine is reset. If you install Extra G3 Interface Unit, you can select “G3-1” or “G3-2” depending on the number of the installed unit.

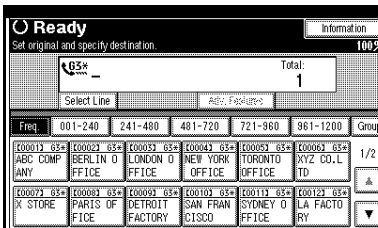

G4

ISDN line is selected.

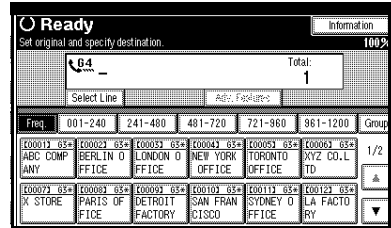

Limitation

- If you select the G4 mode, JBIG compression is not available.

Which line is used for G3 transmissions?

ISDN lines can be used for G3 communication as well as G4 communication. If the machine is connected with an ISDN and analog (PSTN) line, each line can be available by selecting “G3 Auto”. Select “I-G3” when the ISDN line is connected to G3.

Note

- If you wish to use an analog (PSTN) line for G3 transmission, contact your service representative.
- If you use ISDN for G3, you can use Sub-address and UUI.

Auto Identification

This function is used when G4 is selected. The machine first tries a G4 communication and if it cannot connect because the receiver is not a G4 terminal, it automatically switches to G3 and redials.

Note

- ❑ If the G3 line at the destination is connected to the ISDN via a TA (Terminal Adapter) or a PABX, since the called number is on ISDN, it is regarded as G4 and the Auto Identification function may not automatically switch this machine to G3.
- ❑ When you use G3 with ISDN, you can set the sub-address.

1 Press [Select Line].

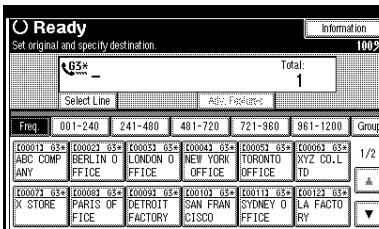

2 Select the line you want to use.

When an optional ISDN Unit is installed.

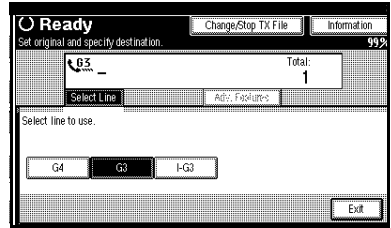

When an optional Extra G3 Interface Unit is installed.

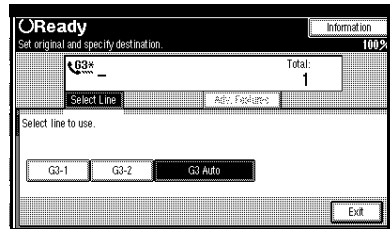

Note

- ❑ If you select "G3 Auto", the machine will use any available line. This increases efficiency.

3 Press [Exit].

The initial display is shown.

Sub Transmission Mode

Book Fax

Use to send book originals from the exposure glass. Pages are scanned in the order shown below.

Limitation

- The Original Position and Page Opening Orientation
- Depending on the paper sizes available on the destination machine, the message may be reduced when printed at the other end.

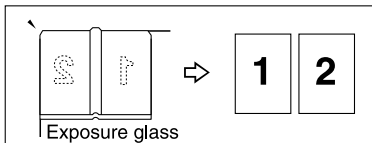

THYS980E

Note

- You can have bound originals scanned in left page first or right page first. You can set which page (left or right) the machine scans first by default with the User Parameters. See p.113 “Changing the User Parameters” (Switch06, Bit6).

Press [Sub TX Mode] ⇒ [Book Fax].

1 Select the size of the original.

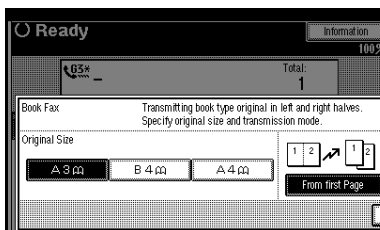

Note

- If you choose A3, the original will be sent using Image Rotation Transmission. See p.59 “Transmission with Image Rotation”.

2 Select [From first Page] or [From second Page].

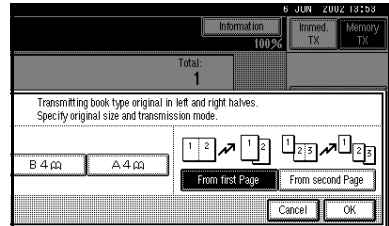

Note

- Select “From first Page” to send a book original from the first page.
- Select “From second Page” if you want to send a cover letter as the first page.

3 Press [OK].

4 Press [OK].

2-Sided Transmission (Double-Sided Transmission)

The optional Document Feeder (ADF) is required.

Use this function to send 2-sided originals.

Note

- Originals placed on the exposure glass cannot be sent.
- The front and back of the scanned original will be printed in order on separate sheets at the other end. The orientation of alternate sheets may be reversed at the other end. If you want to print the original with the same orientation at the other end, specify the “Original Position” and “Page Opening Orientation”.
- This function is only available with Memory Transmission.
- This function is only available using the optional Document Feeder (ADF).
- You can confirm whether both sides were properly scanned in with the Stamp function. See p.53 “Stamp”.

Press [Sub TX Mode] ⇒ [2 Sided Original].

1 Specify “Original Position”.

Note

- Make sure that the specified “Original Position” matches the orientation of originals loaded in the optional Document Feeder (ADF).

2 Specify Page Opening Orientation from [Top to Top] or [Top to Bottom].

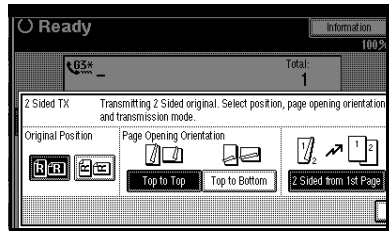

3 Specify the Transmission Mode from [2 Sided from 1st Page] or [1 Sided for 1st Page].

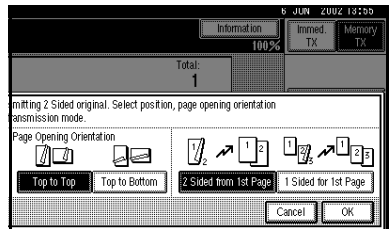

Note

- Select “2 Sided from 1st Page” to send a 2 Sided Original from the first page.
- Select “1 Sided for 1st Page” if you want to send a cover letter as the first page.

4 Press [OK].

5 Press [OK].

Standard Message Stamp

Use this function to stamp a standard message at the top of the first original sent.

There are four types of standard messages: “Confidential”, “Urgent”, “Please phone” and “Copy to corres. section”

You can also program other messages.

Note

- While this function is in use, the second and third lines of the “Label Insertion” are not printed. See p.55 “Programming the Label Insertion”.
- When there is an image around the area where the standard message is to be stamped, that image is deleted.
- To program a standard message, use the “Program/Change/Delete Standard Message” function. See p.96 “Programming and Changing Standard Messages”. See p.97 “Deleting Standard Messages”.

Press [Sub TX Mode] ⇒ [Std. Message].

1 Select the standard message to be stamped, and then press [OK].

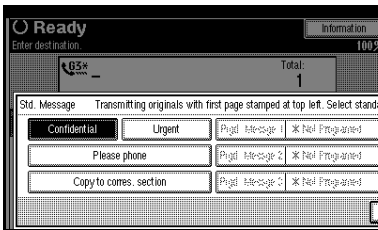

Note

- The machine cannot stamp multiple standard messages.

2 Press [OK].

Sending an Auto Document

If you often have to send a particular page to people (for example a map, a standard attachment or a set of instructions), store that page in the memory as an Auto Document. This saves rescanning the document every time you want to send it.

You can fax an Auto Document by itself, or attach it to a normal fax message.

Preparation

You need to program an Auto Document. See p.97 “Storing and Changing an Auto Document”.

Important

- Whenever you store or change an Auto Document, we recommend that you print the Auto Document list for reference. See p.101 “Reports/Lists”.

Note

- You can attach one Auto Document to each transmission.
- You can store up to 6 Auto Documents (up to 18 with optional Expansion Memory installed). See p.97 “Storing and Changing an Auto Document”.
- Files with Auto Documents are sent by Memory Transmission.
- When sending an Auto Document with another files, the Auto Document is sent first.
- Storing Auto Documents reduces the amount of free memory slightly. Unless you delete the document, free memory will not return to 100%.
- You can print an Auto Document currently stored in memory. See p.48 “Printing documents stored as Auto Documents”.

Press **[Sub TX Mode]** ⇒ **[Auto Document]**.

1 Select Auto Document file, and then press **[OK]**.

When you fax an Auto Document by itself, press then **[TX Stored File(AD) Only]**.

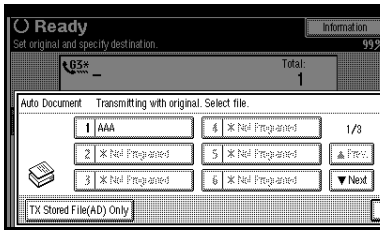

Note

- If you make a mistake, press **[Clear]** or the **[Clear/Stop]** key and try again.

2 Press **[OK]**.

Printing documents stored as Auto Documents

This function is used for printing documents stored as Auto Documents. This function is very convenient as it can be used for confirming the contents of stored files.

Press **[Sub TX Mode]** ⇒ **[Auto Document]**.

1 Select Auto Document file to be printed.

When you fax an Auto Document by itself, press **[TX Stored File(AD) Only]**.

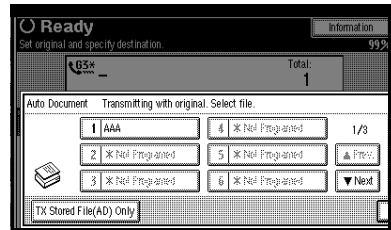

2 Press **[Print File]**.

3 Press the **[Start]** key.

Once the printing has been completed, the display will return to step **1**.

Note

- To cancel printing, press **[Cancel]**. The display will return to step **1**.

4 Press **[Cancel]**.

Return to the initial display.

Note

- You can also send Auto Documents. See p.47 “Sending an Auto Document”.

Sending a Stored File

Use this function to send documents that are stored in the Document Server. You can specify and send multiple documents, and also send them with scanned originals all at once.

You can also print the stored originals with **[Print File]**. See p.51 “Printing stored documents”.

Preparation

Store the documents to be sent in advance. See p.84 “Using the Document Server”.

Sending stored documents

The machine sends documents that are stored in the Document Server.

The documents stored in the Document Server can be sent again and again until they are deleted. Once sent, documents are stored into the Document Server. Therefore, you can send them in just one operation without having to set your originals again.

Limitation

- You cannot use the following transmission methods.
 - Free Polling Transmission
 - Default ID Transmission
 - ID Override Transmission
 - Immediate Transmission
 - Parallel Memory Transmission
See p.57 “Parallel Memory Transmission”.
 - On Hook Dial
 - Manual Dial

Note

- Only documents stored using the fax feature can be sent. Documents stored using the copy feature, printer feature or scanner feature cannot be sent.
- You can specify a maximum of 30 documents at one time.
- The machine can send a total of 400 pages in one operation. With the optional Expansion Memory, it can send a maximum of 1,000 pages.
- The specified documents are sent with the scan settings made when they were stored.
- Received messages cannot be specified as stored documents.

Press **[Sub TX Mode]** ⇒ **[Select Stored File]**.

1 Select the documents to be sent.

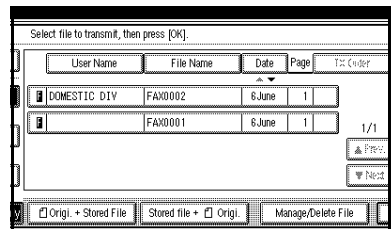

Note

- When multiple documents are selected, they are sent in the order of selection.
- Press **[TX Order]** to arrange the order of the documents to be sent.
- Press **[File Name]** to place the documents in alphabetical order.
- Press **[User Name]** to place the documents in order by the programmed User Name.
- Press **[Date]** to place the documents in order by the programmed date.

Specifying documents from the “File List”

- ❶ Press [▲ Prev.] or [▼ Next] to display the documents to be sent.
- ❷ Select the file name.

Specifying documents from the “User Name”

- ❶ Press [Search by User Name].

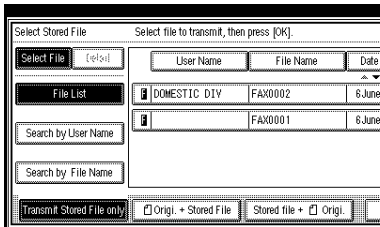

- ❷ When the User Code is programmed, press the User Name of the registered document, and then go to step ❹.

Note

- These User Names are programmed in the User Code in the “System Settings”.
- To search by entering the User Name, press [Non-programmed Name], and then go to step ❸. Partial matching is used to search for the User Name.

- ❸ When the User Code is not programmed, enter the User Name.
- ❹ Press [OK].
- ❺ Select the file name to be sent.

Specifying documents from the “File Name”

- ❶ Press [Search by File Name].

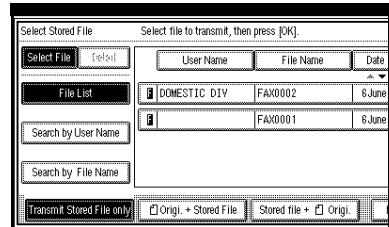

- ❷ Select the file name to be sent, and press [OK].

Note

- Partial matching is used to search for the file name.

- ❸ Select the file name to be sent.

- ❹ If you select a document with a password, enter the password.

If the document does not have a password, proceed to step ❹.

- ❺ Press [OK].

- ❻ When you want to add your originals to the stored documents and send them all at once, press [Orig. + Stored File] or [Stored file + Orig.].

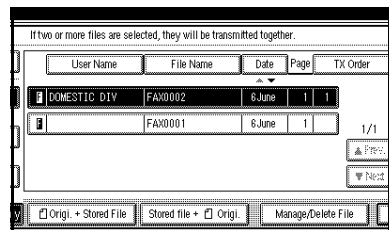

When sending only the stored documents, go to step ❺.

Note

- When [**Orig. + Stored File**] is pressed, the machine sends the “Originals” and then “Stored Files”. When [**Stored file + Orig.**] is pressed, the machine sends the “Stored Files” and then “Originals”.
- The added originals are not stored.

5 Press [OK].**Note**

- To add an original to the stored documents, place the original, and then select any scan settings you require.

6 Press [OK].

Specify the destination, and then press the [**Start**] key.

Printing stored documents

Use this function to print the documents stored in the Document Server.

Note

- Only documents stored using the fax feature can be printed. Documents stored using the fax feature are prefixed with an “F” in front.
- You can print the documents saved from the copy or the printer function with the Document Server. You cannot print the documents saved from the scanner function with this mode.
- Received messages cannot be specified as stored documents.
- You can also print the first page only to check the content of the original.
- You can specify and print multiple documents.

- When specifying and printing multiple documents, page numbers are put on all the files. You can specify whether to put page numbers on your files in “User Parameters”. See p.113 “Changing the User Parameters” (Switch18, Bit3).

Press [**Sub TX Mode**] ⇒ [**Select Stored File**].

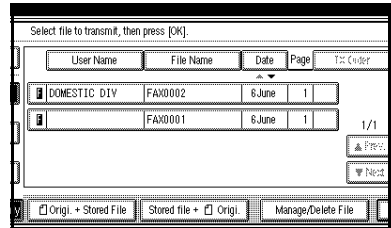
1 Select the document to be printed.**Note**

- Press [**File Name**] to place the documents in alphabetical order.
- Press [**User Name**] to place the documents in order by the programmed User Name.
- Press [**Date**] to place the documents in order by the programmed date.
- To see details of the selected document, press [**Detail**]. To return to the standby menu, press [**File List**].

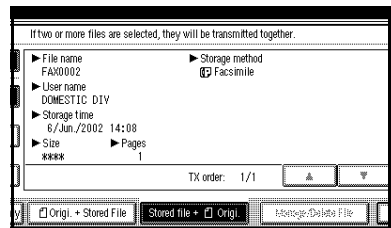

Selecting a document from “File List”

- 1 Press [**▲ Prev.**] or [**▼ Next**] to display the document to be sent.
 - 2 Select the file name.
-

Specifying a document from the “File Name”

- 1 Press [**Search by File Name**].

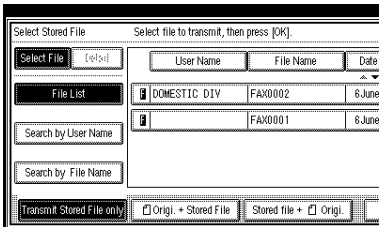

- 2 Enter the file name to be printed, and then press [**OK**].

Note

- Partial matching is used to search for the file name.

Reference

See “Entering Text” in the General Settings Guide.

- 3 Select the file name.
-

Specifying a document from the “User Name”

- 1 Press [**Search by User Name**].

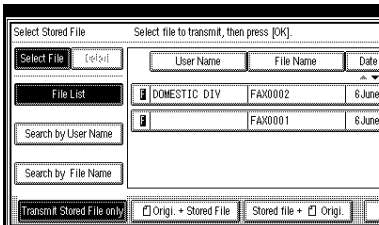

- 2 Press the **User Name** of the document to be sent.

Note

- To search by entering the User Name, press [**Non-programmed Name**], and then enter the User Name. The User Name is searched by partial matching.

Reference

See “Entering Text” in the General Settings Guide.

- 3 Press [**OK**].

- 4 Select the file name.

- 2 Press [**Print File**] or [**Print 1st Page**].

When [**Print File**] is pressed, the machine prints all the pages. When [**Print 1st Page**] is pressed, the machine prints only the first page.

Limitation

- When “Print 1st Page” is selected, originals larger than size A4 are printed after they are reduced to A4 size.
- The machine can print up to 30 files using the “Print 1st Page” function.

Note

- To print both sides, press [**Print 2 Sides**].

- 3 Press the [**Start**] key.

Note

- When only the first page is printed, the file name is printed at the top of the paper.
- To cancel printing, press [**Cancel**].

Stamp

The optional Document Feeder (ADF) is required.

When sending a fax message using the optional Document Feeder (ADF), the machine can stamp a circle mark at the bottom of the original. When sending a 2-sided document, the document is marked at the bottom of the front page and top of the rear page. This stamp indicates that the original has been successfully stored in memory for Memory Transmission, or that it has been successfully sent for Immediate Transmission.

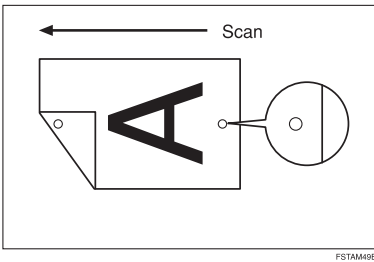

Note

- Do not open the optional Document Feeder (ADF) while scanning a document. A document jam could occur.
- Stamp only works when scanning from the optional Document Feeder (ADF).
- When the stamp starts getting lighter, replace the cartridge. See p.153 "Replacing the Stamp Cartridge".
- If a page was not stamped even though the Stamp function is turned on, you need to resend that page.

- If you use this function often, you can set the default in "General Settings/Adjustment" so that this function is always on. In this case, Stamp can easily be turned off for any single transmission by pressing **[Stamp]**. See p.102 "General Settings/Adjustment".

To set the stamp, press **[Sub TX Mode]** ⇒ **[Stamp]** and **[OK]**.

Note

- To cancel the stamp, press **[Stamp]** again before pressing **[OK]**.

Transmission Options

This section describes various functions that you can switch on and off for any particular transmission by following the procedure at the end of this section.

In addition, if you frequently use a certain option configuration, you can change the default home position (on or off) of each option.

Fax Header Print

In some cases, you may wish the other party to receive an unmarked copy of your original. In this case, you can switch FAX HEADER off.

When the Fax Header is set to "ON", the stored name is printed on the receiver's paper.

You can store two Fax Headers: "First Name" and "Second Name".

For example, if you store your department name in one and your organization name in the other, you could use the first when sending internal faxes and the second for external faxes.

Note

- ❑ If you used the number keys to specify the receiver, the first header name will be printed on the receiver's paper.

Label Insertion

With this function you can have the receiver's name printed on the message when it is received at the other end. The name will be printed at the top of the page and will be preceded by "To". See p.96 "Programming and Changing Standard Messages".

Note

- ❑ You can switch this function on and off with "Gen. Settings/Adjust" . See p.102 "General Settings/Adjustment". It is convenient to set frequently used settings in the General Settings/Adjustment and use "Transmission Options" for occasionally used settings.
- ❑ When there is an image around the area where the Label is to be printed, that image is deleted.

Sender Stamp

When there is data, such as the User Name and department name, programmed into the User Code, you can have the machine print a sender stamp on the right edge of your paper.

Note

- ❑ Enter the User Name in System Settings.
- ❑ You can switch this function on and off with "Gen. Settings/Adjust" .

Reduced Image Transmission

Using this function, your message is sent at a reduced size (93%) with a blank margin on the left.

Note

- ❑ You can switch this function on and off with "Gen. Settings/Adjust" . See p.102 "General Settings/Adjustment". It is convenient to set frequently used settings in the General Settings/Adjustment and use "Transmission Options" for occasionally used settings.
- ❑ This function is not available with Immediate Transmission or a specified transmission of a stored document.
- ❑ Image Rotation is not available with this function.

Auto Reduce

When this function is turned on, if the receiver's paper is smaller than the paper you are sending on, the message is automatically reduced to fit onto the paper available at the other end.

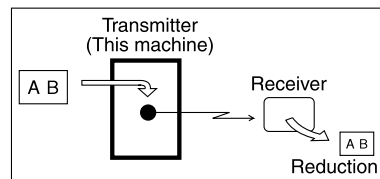

Important

- If you turn this function off, the scale of the original is maintained and some parts of the image may be deleted when printed at the other end.

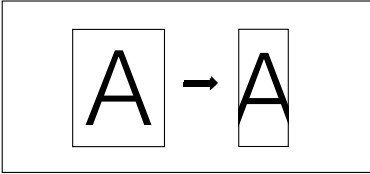

ND1X02E1

Note

- You can switch this function on and off with "Gen. Settings/Adjust". See p.102 "General Settings/Adjustment". It is convenient to set frequently used settings in the General Settings/Adjustment and use "Transmission Options" for occasionally used settings.

Default ID Transmission

If you turn this function on, transmission will only take place if the destination's Polling ID is the same as yours. This function can stop you from accidentally sending information to the wrong place (you need to coordinate Polling ID's with the other party).

Note

- You can switch this function on and off with "Gen. Settings/Adjust". See p.102 "General Settings/Adjustment". It is convenient to set frequently used settings in the General Settings/Adjustment and use "Transmission Options" for occasionally used settings.

Selecting transmission options for a single transmission

Press **[Sub TX Mode]** ⇒ **[Options]**.

1 Select options to be set up.

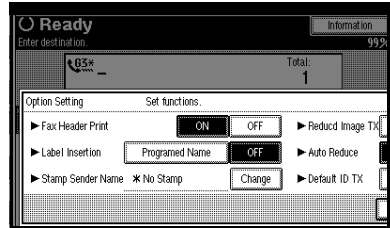

Programming the Fax Header Print

1 Press **[ON]** to specify "Fax Header Print".

Note

- To close the option settings, go to step 2.

Programming the Label Insertion

1 Press **[Programmed Name]** in "Label Insertion".

Note

- To close the option settings, go to step 2.

Programming the Stamp Sender Name

- 1 Press **[Change]**.
- 2 Press the name of the user to be stamped.

 **Note**

- The set User Name is displayed, when the User Code has been stored. See “User Code” in the General Settings Guide.
- You can switch titles when you press on the Title key.
- To stamp a non-registered User Name, press **[Non-programmed Name]**, and then enter the User Name.
- If you do not want to stamp the sender’s stamp, press **[No Stamp]**.

- 3 Press **[OK]**.

 **Note**

- To close the option settings, go to step 2.

Programming the Reduced Image TX

- 1 Press **[ON]** in “Reduced Image TX”.

 **Note**

- To close the option settings, go to step 2.

Programming the Auto Reduce

- 1 Press **[ON]** in “Auto Reduce”.

 **Note**

- To close the option settings, go to step 2.

Programming the Default ID TX

- 1 Press **[ON]** in “Default ID TX”.

 **Note**

- To close the option settings, go to step 2.

- 2 Press **[OK]**.

The screen returns to the Sending menu screen.

 **Note**

- When changing the settings, **[Option Settings]** will be highlighted in dark.

- 3 Press **[OK]**.

- 4 Set the destination, and then press the **[Start]** key.

- 5 Press **[OK]**.

 **Note**

- The Sub Transmission menu is shown.

- 6 Press **[OK]**.

- 7 Dial, and then press the **[Start]** key.

More Transmission Functions

If Memory Runs Out While Storing an Original

If you run out of memory while storing an original (free space reaches 0%), “Memory is full. Cannot scan more. Transmission will be stopped.” is displayed.

Press **[Exit]** to transmit the stored pages only.

Note

- In default, scanned pages are sent. To change the settings to delete scanned pages, contact your service representative.

Parallel Memory Transmission

This function dials while the original is being scanned. Standard Memory Transmission stores the original in memory, then dials the destination. Parallel Memory Transmission allows you to quickly determine whether a connection was made. In addition, this function scans the original faster than Immediate Transmission. This is useful when you are in a hurry and need to use the original for another purpose.

Limitation

- Standard Memory Transmission is used instead of Parallel Memory Transmission in the following cases.
 - When the line is busy and could not be connected to
 - With Send Later

- When you store an original for Memory Transmission while another communication is in progress
- When two or more destinations are specified
- When you send only an Auto Document
- When the first page of an original is placed on the exposure glass
- When you send messages stored in the Document Server

Note

- You can turn this function on or off with the User Parameters. See p.113 “Changing the User Parameters” (Switch07, Bit2).
- Standard Memory Transmission may be used instead of Parallel Memory Transmission depending the optional equipment installed if there is not enough free memory left.
- If you use this function, the Memory Storage Report will not be printed.
- If the **[Clear/Stop]** key is pressed, an original is jammed or memory runs out during Parallel Memory Transmission stops. The Transmission Result Report is printed and files are deleted.
- When Parallel Memory Transmission is used, the total number of originals in “Fax Header Print” is not automatically printed.

Checking the Transmission Result

- Turn the Transmission Result Report on if you want a report to be printed after every successful transmission. See p.19 “Memory Transmission”, *Facsimile Reference (option)* <Basic Features>.
- If you leave the Transmission Result Report off, the report will not be printed after every transmission. However, if a transmission fails, a Communication Failure Report will be printed instead. See p.61 “Communication Failure Report”.
- You can also check the transmission result by examining the Journal. See p.19 “Printing the Journal”.
- You can either print or scroll through the Journal on the display. See p.21 “Checking the Transmission Result (TX File Status)”.

Automatic Redial

If a fax message could not be transmitted because the line was busy or an error occurred during transmission, redialing is done 5 times in 5 minutes intervals (these figures vary according to which country you are in).

If redialing fails after four redials, the machine cancels the transmission and prints a Transmission Result Report or Communication Failure Report.

Batch Transmission

If you send a fax message by Memory Transmission and there is another fax message waiting in memory to be sent to the same destination, that message is sent along with your original. Several fax messages can be sent with a single call, thus eliminating the need for several separate calls. This helps save communication costs and reduce transmission time.

Fax messages for which the transmission time has been set in advance are sent by batch transmission when that time is reached.

Note

- You can turn this function on or off with the User Parameters. See p.113 “Changing the User Parameters” (Switch14, Bit2).
- The originals to be transmitted at a specific time will be sent at time.
- If the line is busy because originals are under stand-by, they may not be transmitted in turn once scanning has been carried out.

ECM (Error Correction Mode)

This function automatically sends data that was not transmitted successfully using a system that complies with international standards.

ECM requires that the destination machine has the same function.

Note

- You can turn this function on or off with the Key Operator Settings. See p.112 “ECM”.

Broadcasting Sequence

If you dial several destinations for the same message (Broadcasting), the messages are sent in the order in which they were dialed. If the fax message could not be transmitted, the machine redials that destination after the last destination specified for Broadcasting. For example, if you specify four destinations A through D for broadcasting, and if the lines to destinations A and C are busy, the machine dials the destinations in the following order: A, B, C, D, A, and C.

Checking the Transmission Progress

To check which destinations the fax message has been sent to so far, print the TX file list.

Dual Access

The machine can scan other messages into memory even while sending a fax message from memory, receiving a message into memory, or automatically printing a report. Since the machine starts sending the second message immediately after the current transmission terminates, the line will be used efficiently.

Note

- Note that during Immediate Transmission or when in User Tools mode, the machine cannot scan an original.

Transmission with Image Rotation

For most purposes, place A4, 8¹/₂"×11" originals in the landscape direction (☐). If you place an A4, 8¹/₂"×11" original in the portrait direction (☐), the image will be sent rotated by 90°. Providing the receiver has A4, 8¹/₂"×11" landscape paper (☐), the message will be printed the same size as the original.

Note

- This function is not available with Immediate Transmission.
- When Image Rotation is used, all messages are sent by normal Memory Transmission.

Simultaneous Broadcast

The optional ISDN Unit or Extra G3 Interface Unit is required.

The Standard Broadcast function sends faxes one at a time to multiple destinations in the order of specified destination numbers.

The Simultaneous Broadcast function, however, can send faxes three at a time to multiple destinations by transmitting simultaneously over different lines.

This results in a shorter overall transmission time.

Note

- This function can use a maximum of 3 lines simultaneously.
- When using the optional Extra G3 Interface Unit, if you set the line selection as "G3 Auto Select" beforehand, the machine will use whichever G3 line is not busy. This increases efficiency.

JBIG Transmission

The optional Fax Function Upgrade Unit is required.

If you use JBIG (Joint Bi-level Image Experts Group) compression, you can send photographic originals faster than the other compression method. You can only use this function with G3/I-G3 line type.

Limitation

- This function requires that the other party's fax machine has both the JBIG function and ECM function (G3 communication only).

Note

- When the optional Extra G3 Interface Unit is installed, JBIG receptions of "G3-2" lines are standard.
- If ECM is turned off, JBIG Transmission is not available. See p.112 "ECM".

Printed Report

Memory Storage Report

This report is printed after an original is stored in memory. It helps you review the contents and the destinations of stored originals. Even if the machine is set up not to print this report, it is still printed if an original could not be stored.

Note

- You can turn this report on and off. See p.113 “Changing the User Parameters” (Switch03, Bit2).
- You can choose whether to include part of the original image on the report. See p.113 “Changing the User Parameters” (Switch04, Bit7).
- If you use Parallel Memory Transmission, the Memory Storage Report will not be printed.

Transmission Result Report (Memory Transmission)

This report is printed when a Memory Transmission is completed so you can check the result of the transmission. If two or more destinations are specified, this report is printed after the fax message has been sent to all the destinations. If the machine is set up not to print this report and the fax message could not be successfully transmitted, a Communication Failure Report is printed. See p.61 “Communication Failure Report”.

Note

- You can turn this function on or off with the User Parameters. See p.113 “Changing the User Parameters” (Switch03, Bit0).
- You can choose whether to include part of the original image on the report. See p.113 “Changing the User Parameters” (Switch04, Bit7).
- The “Page” column gives the total number of pages. The “Not Sent” column gives the number of pages that could not be sent successfully.

Communication Failure Report

This report is only printed if the Transmission Result Report is turned off and a message could not be successfully transmitted with Memory Transmission. Use it to keep a record of failed transmissions so you can send them again.

Note

- You can choose whether to include part of the original image on the report. See p.113 “Changing the User Parameters” (Switch04, Bit7).
- The “Page” column gives the total number of pages. The “Not Sent” column gives the number of pages that could not be sent successfully.

Transmission Result Report (Immediate Transmission)

If you turn this report on, a report will be printed after every Immediate Transmission so you have a record of whether the transmission was successful or not. If the machine is set up not to print this report and the fax message could not be successfully transmitted, the Error Report is printed instead.

4

Note

- You can switch this report on or off in the User Parameters. See p.113 “Changing the User Parameters” (Switch03, Bit5).
- If the page was sent successfully, the “Page” column gives the total number of pages that was sent successfully.

5. Reception Features

Reception

Immediate Reception

Each page of a fax message is printed as soon as it is received. This method is used for standard fax messages.

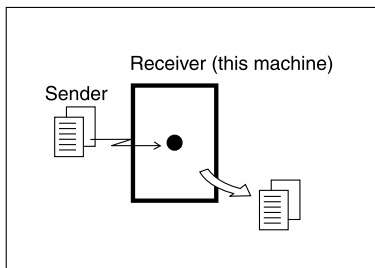

ND1X00E2

Normally this machine receives messages by Immediate Transmission. But Memory Reception is used when "Combine 2 Originals", "Multi-copy reception", "Reverse Order Printing reception" or "2-sided Printing" is set to "ON". See p.70 "Printing Options". If the conditions are that Substitute Reception should be used, a fax message is not printed. It will be stored in memory. See p.63 "Memory Reception". See p.64 "Substitute Reception".

Note

- The machine may not be able to receive fax messages when the free memory space is low.
- If free memory reaches 0% during Immediate Reception, any further reception becomes impossible and the current communication is terminated.

Reception resolution

This machine supports **Standard**, **Detail** and **Super fine** resolutions for reception. If you do not have the optional Fax Function Upgrade Unit, faxes sent at **Super fine** resolution will be printed on your machine at **Detail** resolution. This may differ from the sender's intention.

Reception will not take place if there is not enough free memory left. If free memory reaches 0% during Immediate Reception, any further reception becomes impossible and the current communication is terminated.

Memory Reception

The machine waits until all pages of the message have been received into memory before printing the message.

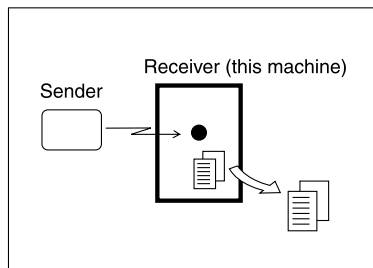

ND1X00E3

This method is used with the following functions:

- Combine 2 originals
See p.73 "Combine 2 Originals".

- Multi-copy when set to multiple copies
See p.72 “Multi-copy Reception”.
- Reverse Order Printing
See p.74 “Reverse Order Printing”.
- Substitute Reception
See p.64 “Substitute Reception”.
- 2-sided Printing
See p.71 “2-Sided Printing”.

Important

- All the messages stored in memory are deleted if the main power switch is turned off for more than one hour.

- The machine may not be able to receive large numbers of messages or messages with a high data content. In such cases, we recommend you switch the above functions off or add a memory card.

Limitation

- The machine may not be able to receive fax messages when the free memory space is low.

Note

- If the free memory space reaches 0% during Memory Reception, the machine can no longer receive the current fax message and stops communicating.

Substitute Reception

In Substitute Reception, a received fax message is stored in memory instead of being printed. Substitute Reception gets used when the machine cannot print any fax messages. Fax messages received using Substitute Reception are automatically printed when the condition which caused the machine to use Substitute Reception is rectified.

Depending on why the machine cannot print, Substitute Reception might get used for all fax messages received or for only those messages that match a specified condition.

The **Receive File** indicator lights to let you know when fax message(s) have been received using Substitute Reception.

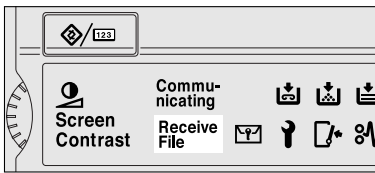



Note

- Reception may not take place if there is not enough free memory.
- If free memory reaches 0% during Substitute Reception, any further reception becomes impossible and the current communication is terminated.





Receiving messages unconditionally

If one of the conditions listed below occurs, the machine receives all fax messages using Substitute Reception.

Why Substitute Reception Occurred	Indication/Status	Solution
Paper is jammed.	 is lit.	Remove the jammed paper. See "  Cleaning Misfeeds" in the General Settings Guide.
Machine is busy printing with other function.	The machine is printing with other function.	The message will be printed after the current job finishes automatically.
Output tray is full.	The message "Following output tray is full. Remove paper." appears.	Remove paper from output tray.
Cover is open.	 is lit.	Close the cover shown in the display.

Receiving messages according to parameter-specified settings

If one of the conditions listed below occurs, the machine receives only those messages that match the conditions specified in the User Parameters. See p.113 "Changing the User Parameters" (Switch05, Bit1,2).

Why Substitute Reception Occurred	Indication/Status	Solution
All trays out of paper.	 is lit.	Add paper. See "  Loading Paper" in the General Settings Guide.
Toner is empty.	 is lit.	Replace the toner cartridge. See "  Adding Toner" in the General Settings Guide.  Note <input type="checkbox"/> As a quicker solution, use another color of toner by changing the color in "2nd Color Choice". See p.75 "2nd Color Choice".
All trays out of action.	The message "This tray is out of order." appears.	Call your service representative.

You can specify the following conditions with the User Parameters. See p.113 "Changing the User Parameters" (Switch05, Bit1,2).

❖ **When Own Name or Own Fax Number is received**

The machine switches to Substitute Reception only when the sender has programmed their Own Name or Own Fax Number. If the power is switched off for more than an hour, all the messages received into memory are deleted. In that case, the Power Failure Report or the Journal can be used to identify which messages are lost so you can ask the senders to transmit them again.

 **Important**

If a sender has not programmed their Own Name or Own Fax Number, the machine may reject an important fax message. We recommend that you ask important senders to program an Own Name or Own Fax Number in advance.

❖ **Free**

The machine switches to Substitute Reception regardless of whether or not the sender has programmed their Own Name or Own Fax Number.

❖ **Polling ID match**

The machine switches to Substitute Reception only when the programmed Polling ID's of the other end and this machine are identical.

❖ **Disable**

The machine does not receive any messages.

Reception Functions

Transfer Station

Transfer Stations allow you to expand the standard functions of your fax machine to set up complex networks. Transfer Stations must be machines of the same make.

The diagram below may make the concept clearer.

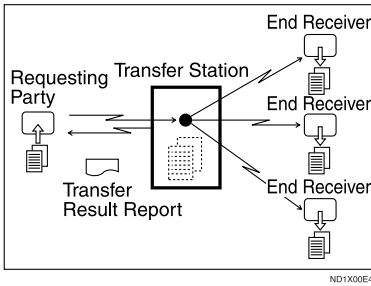

The following terminology is used in this section.

❖ Requesting Party

The machine where the message originates from.

❖ Transfer Station (this machine)

The machine that forwards the incoming message to another destination.

❖ End Receiver

The final destination of the message, that is the machine the Transfer Station sends to. End Receivers must be programmed into Quick Dial or Groups in the Transfer Station.

⚠ Limitation

- ❑ Polling ID's of the Requesting Party and Transfer Station must be identical for this function to work.
- ❑ A Transfer Request cannot be sent, if the fax number of the transfer station (this machine) is not programmed in Quick Dial.
- ❑ If your line number is not programmed at the Transfer Station, reception will not take place. See p.131 "Transfer Report".
- ❑ This machine will not receive a Transfer Request unless it has enough free memory to store two or more destinations dialed from the number keys. See p.31 "Restrictions when dialing with the number keys", *Facsimile Reference (option)* <Basic Features>.
- ❑ If the Requesting Party specifies a Group for the End Receivers and the total number of End Receivers exceeds 500, the Transfer Station cannot transfer the message and sends a Transfer Result Report to the Requesting Party.

Multistep Transfer

The principles of Transfer Stations can be used to build up a multi-step facsimile network where messages are passed through several Transfer Stations. By programming the End Receivers in a Transfer Station Group, you can enable this machine to transfer messages onto other Transfer Stations.

For more information, contact your service representative.

This function can only be used if the machines are made by the same maker.

Reference

See p.44 “Groups”, *Facsimile Reference (option)* <Basic Features>.

Sending the Transfer Result Report

This machine compares the fax number of the Requesting Party with the Requesting Party's number programmed in Quick Dial or Speed Dial. If the lower five digits of the two numbers match, it sends the Transfer Result Report to the Requesting Party.

For example:

- Requesting Party's own dial number:
001813 - 11112222
- Transfer Station's Quick Dial:
03 - 11112222

Transfer Result Report

This reports whether transmission to the End Receivers was successful or not.

Preparation

Program the Requesting Party fax number into a Quick Dial key in advance. See p.40 “Quick Dial”, *Facsimile Reference (option)* <Basic Features>.

Program your own fax number. See p.131 “Transfer Report”.

Program the Polling ID. See p.133 “Programming a Polling ID”.

When the Transfer Station has transferred the message to all End Receivers, it sends the Transfer Result Report back to the Requesting Party. The machine prints the report if it cannot be sent back to the Requesting Party. You must program the fax number of the Requesting Party in Quick Dial in the Transfer Station.

Note

- You can set whether a portion of the original image is printed on the report with the User Parameters. See p.113 “Changing the User Parameters” (Switch04, Bit7).

JBIG Reception

The optional Fax Function Upgrade Unit is required.

It allows you to receive messages sent in the JBIG format.

Limitation

- If ECM is turned off, JBIG Reception is not available.
- This function is not available with G4 communication.

Note

- When the optional Extra G3 Interface Unit is installed, JBIG receptions of “G3-2” lines are standard.

Auto Fax Reception Power-up

This machine can be set to shut down automatically if no one has used it for a while. In these situations, even though the operation switch is off, the machine can still receive incoming messages as long as the main power switch is on.

Important

- Reception is not possible if both the operation switch and main power switch are turned off.

Note

- You can set whether messages are printed as soon as they are received (Immediate Reception) with the User Parameters. See p.113 “Changing the User Parameters” (Switch14, Bit0).
- You can also set that fax messages received by Memory Reception (Substitute Reception) will be printed after the machine is turned on.

Printing Options

Print Completion Beep

When this function is turned on, the machine beeps to let you know when a received message has been printed.

Note

- You can alter the volume of the beep or turn it off completely (set the volume to the minimum level). See p.51 “Adjusting Volume”, *Facsimile Reference (option) <Basic Features>*.

5

Checked Mark

When this function is turned on, a Checkered Mark is printed on the first page of fax messages to help you separate them.

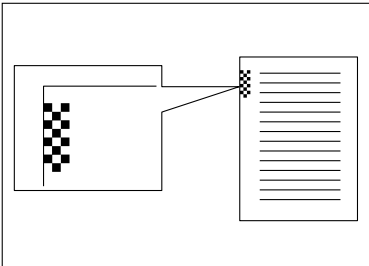

ND1X00ES

Note

- You can turn this function on or off with the Reception Mode. See p.104 “Reception Mode”.

Center Mark

When this function is turned on, marks are printed halfway down the left side and at the top center of each page received. This makes it easy for you to position a hole puncher correctly when you file received messages.

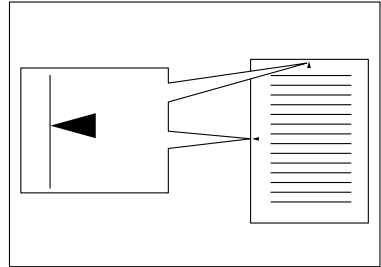

ND1X00ES

Note

- The Center Mark may deviate a little from the exact center of the edge.
- You can turn this function on or off with the Reception Mode. See p.104 “Reception Mode”.

Reception Time

You can have the date and time printed at the bottom of the message when it is received. You can turn this function on or off with the Reception Mode. See p.104 "Reception Mode".

Note

- When a received message is printed on two or more sheets, the date and time is printed on the last page.
- The date and time when the message was printed can also be recorded on the message. If you need this function, please contact your service representative.

2-Sided Printing

You can have a received message printed on both sides of the paper. You can turn this function on or off with the Reception Mode. See p.104 "Reception Mode".

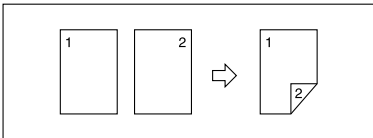

Limitation

- To use this function, all pages of the received document must be of the same size—inform the sending party of this beforehand if necessary. You must also have paper set in your machine of the same size as that sent by the sending party. In 2-Sided Printing, this machine will correctly receive in A3, B4, A4, B5, A5 (11"×17", 8¹/₂"×14", 8¹/₂"×11", 8¹/₂"×5¹/₂"). The following table shows the results that can be achieved when receiving with this machine.

	Originals	Top Binding	Side Binding
A4, B5, A5, 8 ¹ / ₂ " × 11", 8 ¹ / ₂ " × 5 ¹ / ₂ "			
A3, B4, 11" × 17", 8 ¹ / ₂ " × 14"			

ND0X03N3

- This function works only when all pages are of the same width and are received into memory.
- This function cannot be used with Combine 2 originals.

Note

- The machine will use Memory Reception for 2-Sided Printing.

- Printouts may vary depending on how the sender set the originals.
- You can choose to have messages only from selected senders printed in this way. See p.117 “Special Senders to Treat Differently”.

180 Degree Rotation Printing

When printing on both sides of the paper, this machine rotates images as shown in the diagram.

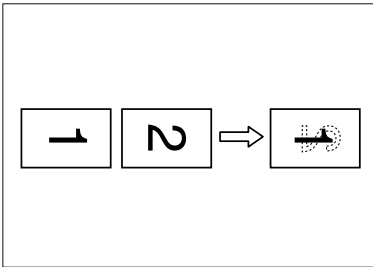

5

Multi-copy Reception

If you switch this function on, multiple copies of each incoming fax message will be printed. You can also choose to have multiple copies made of messages from particular senders. See p.117 “Special Senders to Treat Differently”. See p.104 “Reception Mode”.

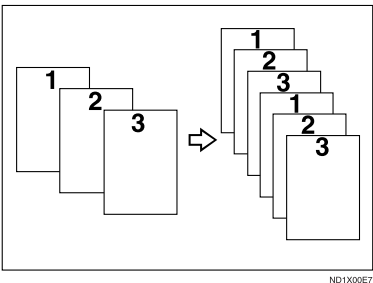

Note

- The maximum number of copies that can be made for each message is 10. If you are using Multi-copy with Specified Senders, the maximum number is 10.
- You can turn this function on or off with the Reception Mode. See p.104 “Reception Mode”.
- The machine will use Memory Reception for Multi-copy Reception.

Image Rotation

If you have set paper in the standard tray , incoming fax messages will be rotated automatically to fit on the paper.

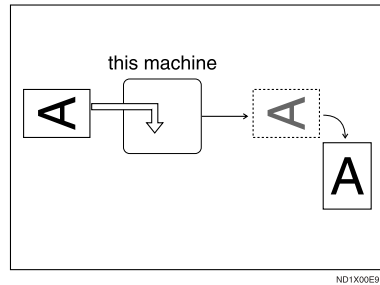

Note

- You can choose to have received messages printed from a specified tray. See p.104 “Reception Mode”.

Combine 2 Originals

When two messages of the same size and direction are received consecutively, they are printed on a single sheet when you turn this function on. This can help you economize on paper.

- Two A5 messages are printed side by side on a sheet of A4 .
- Two B5 messages are printed side by side on a sheet of B4 .
- Two A4 messages are printed side by side on a sheet of A3 .
- Two 8¹/₂"×5¹/₂" messages are printed side by side on a sheet of 8¹/₂"×11" .
- Two 8¹/₂"×11" messages are printed side by side on a sheet of 11"×17" .

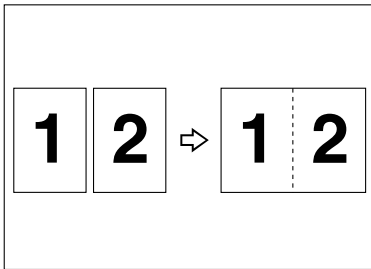

ND1X01E0

Limitation

- This function does not work with messages larger than A5 , B5 , A4 , 8¹/₂" × 11" or 8¹/₂" × 5¹/₂" . When A5 , B5 , A4 , 8¹/₂" × 11" or 8¹/₂" × 5¹/₂" size paper is loaded in the machine, each page of the received message is printed on a single sheet.
- If paper matching the size and direction of a received document is not available, "Combine 2 originals" is not possible.

- When "Combine 2 originals" and "2-Sided Printing" are selected at the same time, combine 2 originals takes priority and 2-sided printing is canceled.

Note

- You can turn this function on or off with the User Parameters. See p.113 "Changing the User Parameters" (Switch10, Bit1).
- This function uses Memory Reception.

Page Separation and Length Reduction

When the size of a received message is longer than the paper loaded in the machine, each page of the message can be split and printed on several sheets, or reduced and printed on a single sheet. For example, this function splits the message if the message length is 20mm (0.79") or longer than the paper used. The message is reduced if it is less than 20mm (0.79") longer. When a message is split, the split mark (*) is inserted at the split position and about 10mm (0.39") of the split area is duplicated on the top of the second sheet.

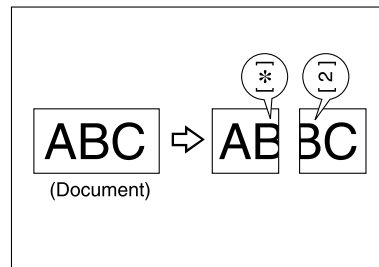

ND1X01E1

Note

- Your service representative can customize this function with the following settings.
 - Reduction
 - Print split mark
 - Overprinting
 - Overprinting length
 - Guideline for split
- You can adjust the overprinting and reduction lengths within the following ranges:
 - Overprinting length: 4mm (0.16"), 10mm (0.39"), 20mm (0.79")
 - Guideline for split: 0~155mm (5mm steps)/0~6.1" (0.2" steps)

Reverse Order Printing

Normally, received pages are printed and stacked on the tray in the order they are received. If you turn this function on, the machine will start printing the message from the last page received.

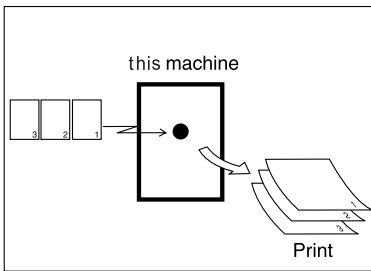

ND1X01E2

Note

- You can turn this function on or off with the Reception Mode. See p.104 "Reception Mode".
- When this function is on, the first page will be printed last.
- This function uses Memory Reception.

Page Reduction

If you receive a message that is longer than the paper in the cassette, usually the machine prints it on two pages. If you turn this function on, the machine reduces the width and length of the received image so that it will fit on one page. If A4 paper size is loaded and a message of B4 size is received, the machine will reduce the message to a single A4 sheet.

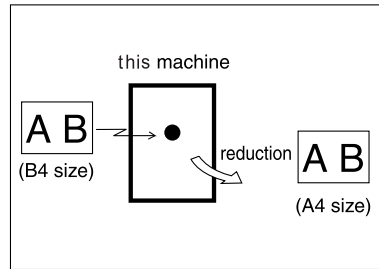

ND1X01E3

Note

- You can turn this function on or off with the User Parameters. See p.113 "Changing the User Parameters" (Switch10, Bit3).
- When this function is used, the printing quality may not be as good as usual.

Reference

See p.73 "Page Separation and Length Reduction".

TSI Print

Usually the sender's Fax Header is printed on received messages. If the sender has not programmed their Fax Header, you will not be able to identify them. However, if you turn this feature on, the sender's Own Name or Own Fax Number is printed instead so you can find out where the message came from. See p.37 "Initial Settings and Adjustments", *Facsimile Reference (option) <Basic Features>*.

Note

- You can turn this function on or off in the User Parameters. See p.113 "Changing the User Parameters" (Switch02, Bit3).

CIL/TID Print

The optional ISDN Unit is required.

Two functions are provided for identification of messages received by G4 (ISDN). If turned on, this information will be printed on every page.

The CIL (Call Identification Line) refers to the combination of the receiver's Own Fax Number, name, the sender's Own Fax Number and name, time, and page number. The TID refers to the name programmed by the sender in their Fax Header.

Limitation

- These functions are available only when receiving in G4 mode.
- If the sender's TID contains double-byte characters (for example Chinese characters), the TID will not be printed even if TID Print is turned on.

Note

- You can turn CIL and TID on or off in the User Parameters. See p.113 "Changing the User Parameters" (Switch02, Bit5 or Bit6).

FAX Print Color

You can specify a color for any received message, list, report, stored document, or auto document. You can choose the color of toner from Black, Cyan, Magenta.

Limitation

- The color specified for 2nd Color Choice can not be used as a FAX Print Color.
- This function is disabled in any printing with the LAN FAX or Document Server.

Note

- You can change the color with Reception Mode. See p.104 "Reception Mode".

2nd Color Choice

If this function is specified, the machine can print with 2nd Color when the machine has run out of default toner. It is useful that the 2nd toner use as a reserve of toner.







Limitation



- The color specified for FAX Print Color can not be used as a 2nd Color Choice.

Note









- You can turn this function on and select the color with Reception Mode. See p.104 "Reception Mode".
- If the machine has run out of 2nd Color, there is no additional substitution.

When There is No Paper of the Correct Size

If there is no paper in your machine that matches the size of a received message, the machine will choose a paper size based upon the paper you have available. For example, if your machine has 8 1/2"×11"  and A3  loaded and you receive a A4  size message, check the A4  column of the following table. The paper size at the top has the highest priority. In this case, since 8 1/2"×11"  is a higher priority than A3 , the message is printed on 8 1/2"×11" .

If only B5  is loaded and you receive an A3  message, the received message is stored in memory and will not be printed.





◆ Priority Table

		Received Image Size							
		A3, 11"×17" 	B4 	A4, 8 1/2"×11" 	A4, 8 1/2"×11" 	B5 	8 1/2"×14" 	F/F4 	
Paper Sucker Priorities	1	A3 	B4 	8 1/2"×11" 	A4 	B5 	8 1/2"×14" 	F/F4 	
	2	11"×17" 	A3 	8 1/2"×11" 	A4 	B5 	A4 	8 1/2"×14" 	
	3	A4 	11"×17" 	A4 	8 1/2"×11" 	B4 	A4 	A4 	
	4	A4 	B5 	A4 	8 1/2"×11" 	A4 	8 1/2"×11" 	A4 	
	5	8 1/2"×11" 	B5 	F/F4 	A3 	A4 	8 1/2"×11" 	8 1/2"×11" 	
	6	8 1/2"×11" 	A4 	8 1/2"×14" 	F/F4 	8 1/2"×11" 	F 	8 1/2"×11" 	
	7	F/F4 	A4 	A3 	11"×17" 	8 1/2"×11" 	B4 	B4 	
	8	B4 	8 1/2"×11" 	B4 	B4 	F/F4 	A3 	A3 	
	9	8 1/2"×14" 	8 1/2"×11" 	11"×17" 	8 1/2"×14" 	A3 	11"×17" 	11"×17" 	
	10	F/F4 	5 1/2"×8 1/2" 	11"×17" 	5 1/2"×8 1/2" 	5 1/2"×8 1/2" 	5 1/2"×8 1/2" 	5 1/2"×8 1/2" 	
	11	8 1/2"×14" 	5 1/2"×8 1/2" 	8 1/2"×14" 	5 1/2"×8 1/2" 	5 1/2"×8 1/2" 	5 1/2"×8 1/2" 	5 1/2"×8 1/2" 	
	12		A5 		A5 	A5 			
	13		A5 		A5 	A5 			
	14		B5 		B5 	B5 			
	15		B5 		B5 	B5 			

 Portrait  Landscape  Image Rotation

GFRXPSE

Page Reduction	Disabled
Reduction in Sub-scan Direction	Enabled
Page Separation Threshold	20mm (0.79")
Width or Length Priority	Width

-   and   indicate that the message is split over two pages of paper with the orientation and size shown.

Note

- Paper placed in the bypass tray is not usually selected for printing a received message. However, you can use this tray if you select the bypass tray as the main paper tray using Reception with Specified Senders. See p.117 “Special Senders to Treat Differently”.

- Widths that this machine can receive are A4, B4 and A3. Any messages narrower than A4 are sent as A4 width with the length unchanged.

- The paper size used to print a received message may be different from the size of the sent original.

- If the paper type is set to **[Thick paper]** or **[OHP]**, papers in the tray will not be used for printing. See p.78 “The trays that cannot be used for printing fax documents”.

Reference

- See p.73 “Page Separation and Length Reduction”.
- See p.74 “Page Reduction”.
- See p.72 “Image Rotation”.

"Just Size" Printing

If you turn this function on and no paper tray is stocked with paper of a suitable size to print a received document, a message will appear on the display prompting you to load paper of the required size. When you have loaded the new paper, you can then print the message.

Two messages can appear:

- Paper Cassette

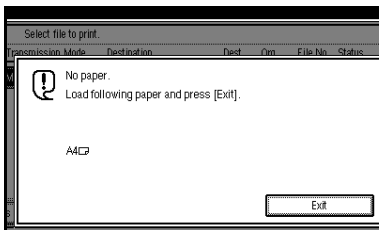

- Bypass Tray

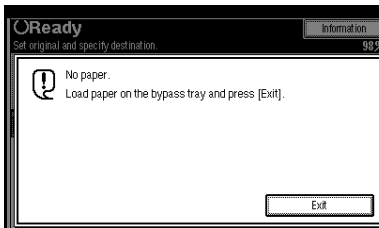

! Limitation

- If the paper tray is pulled out, you will not be able to print the message. Be sure to return the paper tray.
- The action that follows pressing **[Exit]** varies depending on the status of the machine when the message occurred.
 - If any received documents or reports were being printed automatically, the printer automatically continues printing from where it had left off.

- If any documents or reports were being printed manually, the printer does not resume the printing. Perform the operations from the beginning again.

Note

- You can turn this function on or off with the User Parameters. See p.113 "Changing the User Parameters" (Switch05, Bit5).

Having Incoming Messages Printed on Paper from the Bypass Tray

The optional Bypass Tray is required to use this feature.

You can have messages sent from Specified Senders printed on paper from the bypass tray. This is useful if you need messages printed on a size of paper not stocked in the paper cassette(s).





You can set up to a maximum of 100 standard paper in the bypass tray.

! Limitation

- You cannot output the received paper into the optional Finisher Unit, when using this function. The paper will be delivered into the machine's paper tray, even when the optional Finisher Unit has been set as the output tray. See "Output Tray Settings" in the General Settings Guide.

Note

- The print area is determined by optional Expansion Memory, Resolution, and the vertical length of originals.



- 5
- ❑ If paper longer than 458mm is used, the paper may get wrinkled, it may not be sent, or a paper jam may occur.
 - ❑ Before you can use this function, you need to turn on Authorized Reception (Initial Setup Reception Mode settings), program the Specified Senders (Key Operator Settings) along with the Paper. See p.104 "Reception Mode". See p.117 "Special Senders to Treat Differently".
 - ❑ The machine can detect the paper sizes of A4 , A3  (8 1/2"×11" , 11"×13" ). When you load any other size of paper, specify the paper size. See p.122 "Programming "Bypass Tray Paper Size"".
 - ❑ If the specified paper size and the size of paper set in the bypass tray do not match, paper jams may occur or the image may be truncated.
 - ❑ If messages are printed on paper smaller than A4, the image may be truncated or split across sheets.
 - ❑ If you use this function, Image Rotation and 180 Degree Rotating Printing are not possible.

Having Incoming Messages Printed on Paper from the Large Capacity Tray (LCT)

The optional Large Capacity Tray (LCT) is required to use this function.

You can set the User Parameter so that the priority is given to the Large Capacity Tray (LCT) when printing received messages. See p.113 "Changing the User Parameters" (Switch15, Bit7).

Note

- ❑ The Large Capacity Tray (LCT) takes priority when:
 - "User Parameters" (Switch15, Bit7) is set to "On".
 - "Paper Tray" is set to "Auto Select". See p.104 "Reception Mode".
 - A4   has been selected according to "Priority Table".
 - Paper is loaded in the Large Capacity Tray (LCT).

The trays that cannot be used for printing fax documents

If the paper type is set to [Thick paper] or [OHP], the paper in the tray will not be used for facsimile functions such as printing received documents, lists or reports. Confirm the paper type setting in System Settings. See "Tray Paper Settings" in the General Settings Guide.

Where Incoming Messages are Delivered - Output Tray

G3/G4 Separate Tray

The optional Extra G3 Interface Unit or optional ISDN Unit.

You can specify the document feeding tray for each line. For example, you can specify documents received through the G3 line to be fed to the "Standard Tray" and documents received through the G4 line to be fed to the "Upper Tray", facilitating the separation of files.

Note

- To use this function, specify the line and destination in "G3/G4 Separate Tray". See p.104 "Reception Mode".

Tray Shift

The optional Finisher or Shift Sort Tray Unit is Required.

When the optional Finisher Unit is selected for fax output, you can use the Tray Shift function to have the internal delivery exit move to the left or right whenever a fax or report is printed.

This is useful for separating faxes stacked in the finisher output tray. For example, if the previous incoming fax was output to the left, the next incoming fax will be output to the right and vice-versa.

Note

- You can turn this function on or off with the User Parameters. See p.113 "Changing the User Parameters" (Switch19, Bit0).

5

6. Simplifying the Operation

Programs

If you regularly send messages to a particular destination or transmit using the same functions, you can save a lot of repetitive keypad operations by registering this information in a Keystroke Program.

Registering and Changing Keystroke Programs

Keystroke Programs can be recalled by just pressing a Quick Dial key. The following procedure can be used to program a new Keystroke Program or overwrite an old one.

You can register the following items in Keystroke Programs:

- Memory Transmission, Immediate Transmission, destinations (up to 500 numbers), Resolution, Original Type, G3 or G4 communication mode (Only when a destination is specified with the number keys), Stamp, Send Later, Default ID, Auto Document, Book Fax, Polling Transmission, Polling Reception, Transfer Request, 2-sided transmission, optional functions
- Program name (up to 20 characters)

Important

- We recommend that you print the Keystroke Program list and keep it when you register or change a function. See p.101 "Reports/Lists".

Limitation

- Transfer Request and broadcast transmissions cannot be registered at the same time.

Note

- You cannot change programs which are being used for a Memory Transmission on standby.
- The maximum number of programs you can register is 100 (200 with the optional Fax Function Upgrade Unit).
- Use the same procedure to registering and change programs. Follow the procedure for the items you want to change.
- The method to register or change programs for Copy Function is different from that of Fax Function.

1 Prepare for registering the program.

Note

- The procedure for programming differs depending on the items you want to register.
- Press the **[Clear Modes]** key to cancel programming.

Example of registering a program using Send Later with the fax number "0123456789".

- 1** Press **[0], [1], [2], [3], [4], [5], [6], [7], [8], [9]** with the number keys.
- 2** Press **[Transmission Mode]**.
- 3** Select **[Send Later]**.

4 Enter the time to send. **Note**

- If “Send Later” is already specified, that time is shown. Press the **[Clear Modes]** key to change “Send Later”.

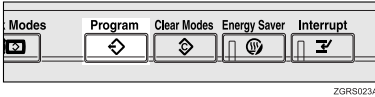
2 Press the **[Program]** key.

The program (Fax) is shown.

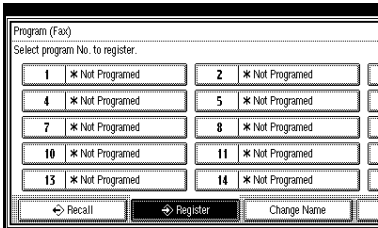
3 Select a program number in which “*Not Programed” is shown. **Note**

- If you make a mistake, press **[Cancel]** and select a program number again.
- When you change a Keystroke Program, press **[Store]** after pressing the program number you want to change. If you make a mistake, press **[Do not Store]** and return to step **3**.

4 Enter the program name, and then press **[OK]**.

The program has been registered.

 **Note**

- If you make a mistake, press **[Backspace]** or **[Delete All]** and try again.
- You should register the program name.

5 Press **[Exit]**.

The initial display is shown.

Using a program

Example of executing a program using Send Later with the fax number “0123456789”.

1 Make sure that the machine is in **Facsimile mode** and the **standby display** is shown. **Note**

- If the standby display is not shown, press the **[Facsimile]** key.

2 Place your original. **Note**

- If you have not a registered destinations or scan settings as a program, enter the fax number for the destination and select any scan settings you require.

3 Press the **[Program]** key.**4** Select a program number you registered.

The initial display is shown.

Then, the registered fax number and time are shown. Transmission Mode is selected.

5 Press the **[Start]** key.

The fax number and specified time are shown on the display and the machine starts to scan the original.

Changing a program name

⚠ Limitation

- ❑ You cannot change the programs names which are being used for the Memory Transmission.

1 Make sure that the machine is in **Facsimile mode** and the **standby display** is shown.

📎 Note

- ❑ If the standby display is not shown, press the **[Facsimile]** key.

2 Press the **[Program]** key.

3 Press **[Change Name]**, and select the program number for the name you want to change.

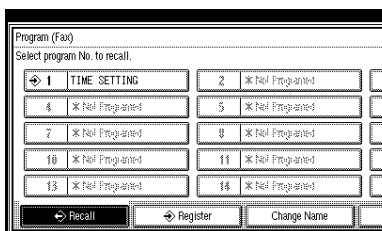

4 Enter a new program name, and press **[OK]**.

The program name is changed.

5 Press **[Exit]**.

The initial display is shown.

Deleting a Program

📎 Note

- ❑ You cannot delete programs which are being used for a Memory Transmission.

❑ If you delete a program, the registered program name is also deleted.

1 Make sure that the machine is in **Facsimile mode** and the **standby display** is shown.

📎 Note

- ❑ If the standby display is not shown, press the **[Facsimile]** key.

2 Press the **[Program]** key.

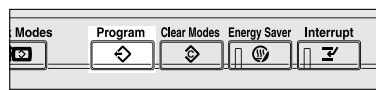

ZGRS023A

3 Press **[Delete]**, and then select the program number you want to delete.

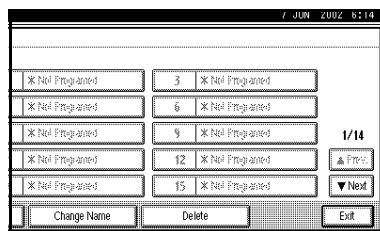

The contents of the program are shown on the display.

4 Press **[Yes]**.

5 Press **[Exit]**.

The initial display is shown.

Using the Document Server

Use this function to store documents in the Document Server of this machine.

The Document Server can store documents from various applications.

The documents that are stored using a facsimile feature are available to transmit by facsimile.

Storing in the Document Server enables the following:

- Once stored, a document can be sent out as many times as you want just by selecting it.
- Storing a document does not use facsimile memory.

You can send and print multiple stored documents as a single document, and also send them with scanned originals at the same time. Follow the instructions under **[Select Stored File]** in **[Sub TX Mode]** when sending or printing stored documents. See p.49 “Sending a Stored File”.

Important

- Data stored in the machine might be lost if some kind of failure occurs. The supplier shall not be responsible for any damage that might result from the loss of data. For long-term storage of data, we recommend the use of DeskTop-Binder V2 Lite or DeskTopBinder V2 Professional (option). For more information, please contact your local dealer.

Note

- The stored documents are not deleted even when there is a power failure or the main power switch is turned off.
- You can specify whether or not the machine automatically deletes documents from the Document Server after a certain number of days. The delete function is pre-configured with the software and automatically deletes any stored document that is more than 3 days (72 hours) old. You can change the setting with “Key Operator Tools — Auto Delete File”. See “Key Operator Tools — Auto Delete File” in the General Settings Guide.
- The fax feature has a memory capacity of approximately 1,000 documents.
- You can store approximately 2,000 pages (ITU-T No.1 chart) in the Document Server, using the copy, facsimile, printer, and scanner features.
- You can store up to 400 pages (1,000 pages with the optional Expansion Memory) per document.

Storing a Document

You can send and store a document at the same time. You can also just store a document.

❖ File names

Files which have been read automatically get names like "FAX0001" or "FAX0002". See p.86 "Setting a File Name".

❖ User Names

You can set this function if necessary to know whom and what departments are stored in the machine. See p.85 "Programming a User Name".

❖ Password

You can set this function so as not to send to unspecified people. See p.86 "Setting a Password".

📌 Note

- The stored documents are given "file names", such as "FAX0001" and "FAX0002", automatically. However, you can change the file names. See p.87 "File Manage".
- You can attach "User Names" to the stored documents. See p.87 "File Manage".

1 Make sure that the machine is in Facsimile mode and the standby display is shown.

If the standby display is not shown, press the **[Facsimile]** key.

2 Place your original, and then select any scan settings you require.

3 Press [Store File].

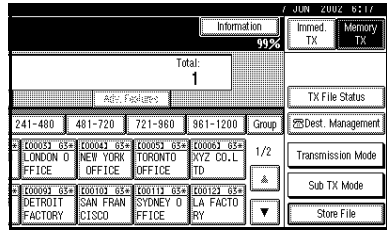

4 Select [Store & Transmit] or [Store only].

Select **[Store & Transmit]** to send documents after they are stored.

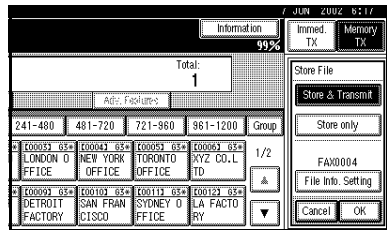

Select **[Store only]** to store documents.

When **[Store only]** is selected, "*****" is shown.

5 Set the User Name, file name and password if necessary.

📌 Note

- If you are not going to set the User Name, file name, or password, go to step 6.
- You cannot change multiple documents at once.

Programming a User Name

📌 Note

- Set a User Name from those that are programmed in the User Code. See "User Code" in the General Settings Guide.

- 1 Press **[File Info. Setting]**.
- 2 Press **[User Name]**.

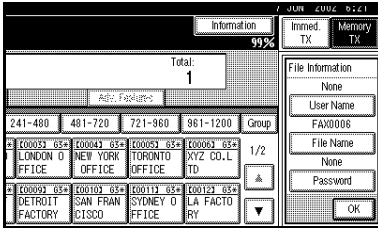

The User Name change menu is shown.

- 3 Press the User Name to be programmed, and then press **[OK]**.

The specified User Name is shown.

Note

- Press the title key to switch between titles.
- To set an unprogrammed User Name, press **[Non-programmed Name]**, and then enter the name. User Names that are entered by pressing **[Non-programmed Name]** are not programmed into the User Code.

- 4 Press **[OK]**.

Setting a File Name

- 1 Press **[File Info. Setting]**.
- 2 Press **[File Name]**.

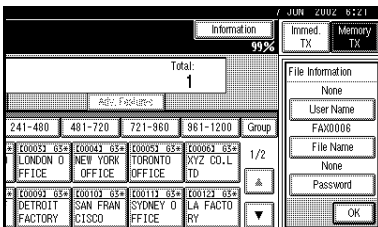

The File Name change menu is shown.

- 3 Enter the file name, and then press **[OK]**.

The changed file name is shown.

Reference

See “Entering Text” in the General Settings Guide.

- 4 Press **[OK]**.

Setting a Password

- 1 Press **[File Info. Setting]**.
- 2 Press **[Password]**.

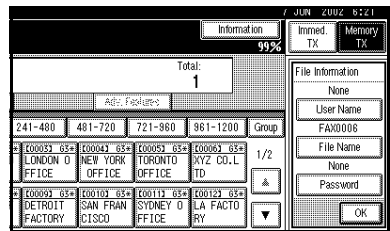

The Password setting menu is shown.

- 3 Enter a password using the number keys, and then press **[OK]**.

*** is shown.

Note

- If you make a mistake, press **[Clear]** or the **[Clear/Stop]** key, and then reenter your password.

- 4 Press **[OK]**.

- 6 Press **[OK]**.

- 7 If you have selected **[Store & Transmit]**, specify the receiver.

Note

- If you have selected **[Store only]**, go to step 8.

- 8 Press the **[Start]** key.

File Manage

You can change the file name, User Name, and password of stored documents.

To change a stored document, delete the document you no longer need, and then reprogram the new document. See p.88 “Delete File”.

Press **[Sub TX Mode]** ⇒ **[Select Stored File]**.

1 Press **[Manage/Delete File]**, and then select the document to be changed.

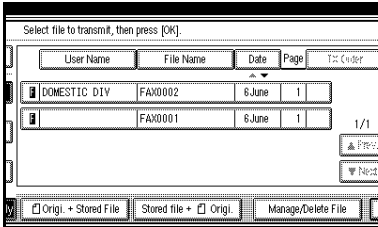

Note

- You can specify multiple documents at one time.

2 If you select a document for which a password is set, enter the password. When a selected file does not have a password, go to step **4**.

3 Press **[OK]**.

4 Change the information of the stored document. Change the desired items.

Changing a User Name

1 Press **[Change User Name]**.

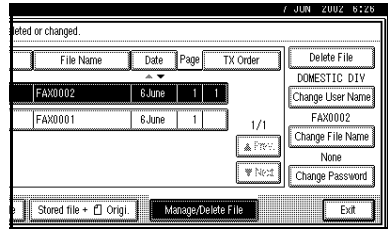

2 Press **[Clear]**.

The User Name is deleted.

3 Enter the new User Name.

Note

- Press the title keys to switch between titles.
- To set an unprogrammed User Name, press **[Non-programmed Name]**, and then enter the name.
- User Names that are entered by pressing **[Non-programmed Name]** are not programmed into the User Code.

Reference

See “Entering Text” in the General Settings Guide.

4 Press **[OK]**.

Changing a File Name

1 Press **[Change File Name]**.

2 Press **[Backspace]** or **[Delete All]**, and then reenter the file name.

Reference

See “Entering Text” in the General Settings Guide.

3 Press **[OK]**.

Changing the Password

- 1 Press [Change Password].
- 2 Enter a new password using the number keys, and press [OK].

- 5 Press [Exit].

Return to the initial display.

Delete File

Use this function to delete your stored documents.

Press [Sub TX Mode] ⇒ [Select Stored File].

- 1 Select [Manage/Delete File].

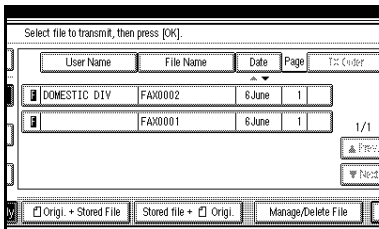

- 2 Select the document you want to delete.

Note

- You can also delete multiple documents at once.
- Enter the password when the Password setting menu is shown.

- 3 Press [Delete File].

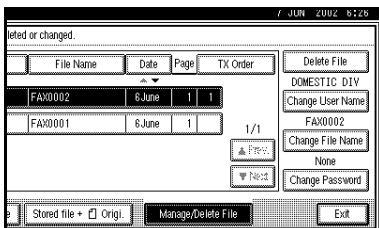

- 4 Press [Delete].

- 5 Press [Exit].

Return to the initial display.

Controlling documents saved in the Document Server from a computer

The fax documents saved in the Document Server can be viewed and controlled from a network computer with DesktopBinder V2 Lite or DesktopBinder V2 Professional installed.

The following operations are available from the computer:

- Displaying documents (Easy Viewer)
- Displaying document properties (Properties)
- Deleting documents (Delete)
- Copying documents to a computer (Copy)
- Printing documents (Print from Document Server)
- Sending documents by fax (Fax from Document Server)
- Exporting documents as files (Export Document)

For more information, see the DesktopBinder V2 operating instructions and Help.

Note

- Settings made in System Settings enable you to send documents to the delivery server. See “Configuring the Network” in the General Settings Guide.

7. Facsimile Features

Function List

Function name	Description	Reference
Prog./Change/Delete		
Program/Change/Delete Quick Dial	When you register a destination in a Quick Dial, you can specify the destination by just pressing the Quick Dial key.	See p.40 "Quick Dial", <i>Facsimile Reference (option)</i> <Basic Features>.
Program/Change/Delete Group	If you program several destinations into a Group, you can dial with just a few key-strokes.	See p.44 "Groups", <i>Facsimile Reference (option)</i> <Basic Features>.
Change Order of Quick Dial Table	Use this function to change the order of the registered Quick Dial Table. It would be convenient to list the receivers that you fax to frequently on the first page of the Quick Dial Table.	See p.94 "Changing the Order of the Quick Dial Table".
Program Title of Quick Dial Table	Use this function to add a name to the title of the Quick Dial Table in order to facilitate finding the desired registered destination.	See p.95 "Programming Title of the Quick Dial Table".
Program/Change/Delete Standard Message	Use this function to program standard messages to be printed at the top of the first page of the original.	See p.96 "Programming and Changing Standard Messages".
Store/Change/Delete Auto Document	Allows you to store a frequently used original in the machine's memory. You can print or send the original directly as necessary.	See p.97 "Storing and Changing an Auto Document".
Program/Change/Delete Scan Size	Register a frequently used original size in advance when you send a message with the Irregular Scan Area function.	See p.16 "Setting a Scan Area", <i>Facsimile Reference (option)</i> <Basic Features>.

Function name	Description	Reference
Print List/Report	<p>This function allows you to print various reports and lists manually. You can print the following reports and lists:</p> <ul style="list-style-type: none"> • Journal See p.19 "Printing the Journal". • Quick Dial list See p.101 "Quick Dial list". • Group Dial list See p.101 "Group Dial list". • Label Insertion list See p.101 "Label Insertion list". • Program list See p.101 "Reports/Lists". • Auto Document list See p.101 "Reports/Lists". 	See p.101 "Reports/Lists".
Gen. Settings/Adjust	<p>Default Transmission Mode and scan settings. When the power is turned on, settings specified here are selected:</p> <ul style="list-style-type: none"> • Memory/Immediate Transmission Switch • Text Size Priority • Original Type Priority • Auto Image Density • Adjust Scan Density • Switch Title of Quick Dial Table • Switch Display • Adjust Sound Volume • Program Fax Information • Fax Header Print Setting • Label Insertion Priority Setting • Reduced Image TX Setting • Auto Reduced Image Setting • Closed Network Priority Setting • Scan End Reset • Transmission Stamp Priority • Line Priority Setting • On hook Mode Release Time • Program Economy Time • Quick Operation Key 	<p>See p.102 "General Settings/Adjustment".</p> <p>See p.37 "Initial Settings and Adjustments", <i>Facsimile Reference (option)</i> <Basic Features>.</p> <p>See p.51 "Adjusting Volume", <i>Facsimile Reference (option)</i> <Basic Features>.</p>

Function name	Description	Reference
Reception Mode	<p>Allows you to switch the following reception functions to on or off:</p> <ul style="list-style-type: none"> • Switch Reception Mode See p.36 "Selecting the Reception Mode", <i>Facsimile Reference (option) <Basic Features></i>. • Authorized Reception See p.120 "Authorized RX". • Forwarding See p.120 "Forwarding". • Reception File Print Quantity See p.121 "Reception File Print Qty". • 2-Sided Print See p.71 "2-Sided Printing". • Reception Reverse Printing See p.74 "Reverse Order Printing". • Paper Tray See p.121 "Paper Tray". • G3/G4 Separate Tray See p.79 "G3/G4 Separate Tray". • Checkered Mark See p.70 "Checkered Mark". • Center Mark See p.70 "Center Mark". • Print Reception Time See p.71 "Reception Time". • FAX Print Color See p.75 "FAX Print Color". • 2nd Color Choice See p.75 "2nd Color Choice". 	<p>See p.104 "Reception Mode".</p> <p>See p.36 "Reception", <i>Facsimile Reference (option) <Basic Features></i>.</p>

Accessing the User Tools

The User Tools allow you to program the machine with your identification, to store frequently used numbers and settings, and customize the default settings to match your needs.

So you can find the User Tool you want quickly and easily, they are grouped by function.

❖ Prog./Change/Delete

Use to program, change or delete: Quick Dial, Group Dial, Title of Quick Dial Table, Order of Quick Dial Table, Auto Documents, Standard Message, Scan Size
See p.40 "Quick Dial", *Facsimile Reference (option) <Basic Features>*.
See p.44 "Groups", *Facsimile Reference (option) <Basic Features>*.
See p.94 "Program/Change/Delete Menu".

❖ Print List/Report

Use to print: the Journal, Group Dial list, Program list, Auto Document list, Quick Dial list, Label Insertion list. See p.101 "Reports/Lists".

❖ General Settings/Adjustment

Use to set defaults for: Transmission Mode (Memory / Immediate), Scan Conditions (Resolution / Auto Image Density / Original Type), Fax Information, Adjust Sound Volume. See p.102 "General Settings/Adjustment". See p.37 "Initial Settings and Adjustments", *Facsimile Reference (option) <Basic Features>*. See p.51 "Adjusting Volume", *Facsimile Reference (option) <Basic Features>*.

❖ Reception Mode

Use to turn on or off: Reverse Order, Checkered Mark, Center Mark, Print RX Time, Multi-copy Reception, Authorized Reception, Special RX Nos., 2-sided printing, Forwarding, Paper Tray Settings, FAX Print Color, and 2nd Color Choice. See p.104 "Reception Mode".

❖ Key Operator Tools

Use to program/check: your name, your fax number, line type, various ID Codes, number of transmitted/received documents. See p.109 "Using Key Operator Settings".

Note

- Each menu appears in the each tab.
- You can switch the display by pressing [**▲ Prev.**] or [**▼ Next**].
- The selected item is highlighted.
- When you specify all the settings, press [**OK**]. If [**OK**] is not pressed, the settings you made might be canceled.
- Press [**Cancel**] to cancel specified settings. The previous display is shown.

Key Operator Code

When Key Operator Code is programmed and turned on, users have to enter a programmed Key Operator Code (maximum 8 digits) to operate the User Tools and Key Operator Tools. This prevents unauthorized people from changing registrations.

Note

- You can turn the Key Operator Code on or off in the “System Settings”.
 - When you set the Key Operator Code active, enter a code (maximum 8 digits) with the number keys and select **[Partial]** or **[All Initial Settings]** to limit access.
 - When **[Partial]** is selected:
Only the Key Operator Tools are protected with a Key Operator Code.
 - When **[All Initial Settings]** is selected:
The Key Operator Tools and User Tools are protected with a Key Operator Code.
- ① Press the **[User Tools/Counter/Inquiry]** key.
If you have selected **[All Initial Settings]**, go to step ③.
 - ② Press **[Facsimile Features]**.
 - ③ Select **[Key Operator Tools]**.
 - ④ Enter a maximum 8 digit Key Operator Code with the number keys.

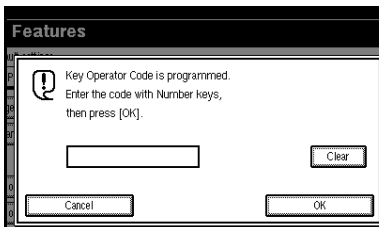

- ⑤ Press **[OK]**.

Note

- If you enter a Key Operator Code that is not registered, the display will return to step ③.

Program/Change/Delete Menu

Changing the Order of the Quick Dial Table

Use this function to change the order of the programmed Quick Dial Table.

It is convenient if you list the receivers that you fax to frequently on the first page of the Quick Dial Table.

 **Note**

- You can only change the order within "Title 1", "Title 2", and "Title 3". You cannot change the order within "Destination List".

Pressing an arrow key will move the selection in the direction of the arrow.

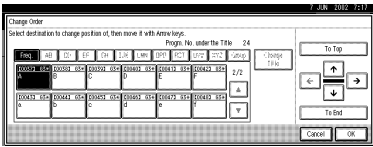

Start in the menu above. By pressing [→], the destination key moves to the right.

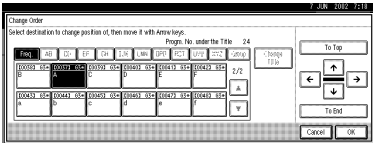

By pressing [↓] from the top menu, the destination key moves down.

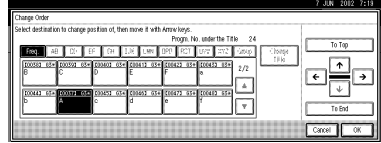

 **Reference**

See p.40 "Quick Dial", *Facsimile Reference (option)* <Basic Features>.

Press the **[User Tools/Counter/Inquiry]** key. See p.7 "Control Panel", *Facsimile Reference (option)* <Basic Features>. And then press **[Facsimile Features]** ⇒ **[Prog./Change/Delete]** ⇒ **[Change Order of Quick Dial Table]**.

- 1** Select the destination key for which you want to change the order.

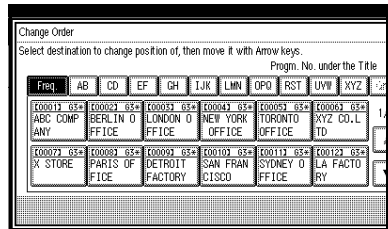

 **Note**

- If the destination key is under a different title, press **[Change Title]** to switch between titles.

2 Press the arrow keys to move the destination key.

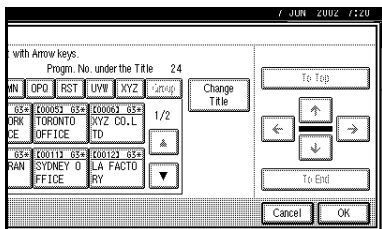

3 Press [OK].

Return to the initial display.

Programming Title of the Quick Dial Table

Use this function to add a name to the title of the Quick Dial Table in order to facilitate finding the desired programmed destination.

As in a telephone directory, there are titles in the Quick Dial Table to facilitate finding the desired receiver from among many destinations.

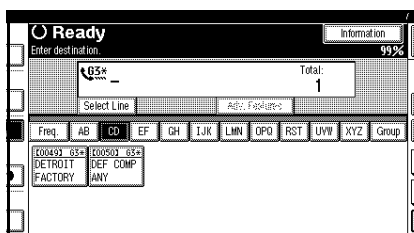

In the menu above, the [CD] page (menu) of the Quick Dial Table is selected. The titles are [Freq.], [AB], [CD], [EF], [GH], [IJK], [LMN], [OPQ], [RST], [UVW], and [XYZ]. For an example, press [EF] to select that page.

On this machine, you can create a Quick Dial Table according to your needs. In creating a Quick Dial Table, you should program titles to facilitate your search process. You can change the type of classification.

Create and use your own titles according to your needs, for example, "Business" and "Private".

Note

- The machine can make four types of Quick Dial Tables. To display a Quick Dial Table different from the one being shown, press [Change Title]. See p.96 "Switching Titles".
- You can program up to four characters for the "Title 1" and "Title 2" keys.
- You can program up to eight characters for the "Title 3" key.
- Use the same procedure program and change the titles.

Press the [User Tools/Counter/Inquiry] key. See p.7 "Control Panel", *Facsimile Reference (option) <Basic Features>*. And then press [Facsimile Features] ⇒ [Prog./Change/Delete] ⇒ [Program Title of Quick Dial Table].

1 Select the title key to program.

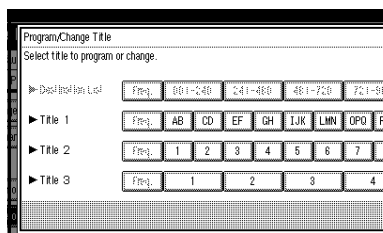

Note

- You cannot make any changes to "Destination List" or "Freq.".

- 2 Enter the name for the title key, and press [OK].

Return to the initial display.

 **Reference**

See “Entering Text” in the General Settings Guide.

 **Note**

- To program another title key, repeat from step 1.

 **Switching Titles**

To specify a fax receiver on the Quick Dial Table, select the title where that receiver is programmed.

You can specify all programmed receivers on the Destination List.

To display the Quick Dial Table in alphabetical order, select “Title 1”. To display the Quick Dial Table that is programmed by user, select “Title 2”.

- 1 Press [Dest. Management].
- 2 Select [Change Title].
- 3 Press the title key to be displayed.
- 4 Press [OK].

The selected title is shown above the “Change Title” menu.

 **Note**

- To cancel changing the title, press [Cancel]. The display will return to step 2.

- 5 Press [Exit]. The initial display is shown.

 **Note**

- This change is only temporary and the setting will be cleared once the power is turned off.
- For information about maintaining this setting, see p.102 “Switch Title of Quick Dial Table”.

Programming and Changing Standard Messages

Use this function to program standard messages to be printed at the top of the first page of the original. It is convenient if you program message such as your own greetings.

 **Note**

- You can program your own messages into [Prog. Message 1], [Prog. Message 2] and [Prog. Message 3] only. You cannot change the “Confidential”, “Urgent”, “Please phone”, or “Copy to corres ...” messages.
- Use the same procedure to program and change your messages.

Press the [User Tools/Counter/Inquiry] key. See p.7 “Control Panel”, *Facsimile Reference (option)* <Basic Features>. And then press [Facsimile Features] ⇒ [Prog./Change/Delete] ⇒ [Program/Change/Delete Standard Message].

- 1 Select a key in which “*Not Programmed” is displayed.

 **Note**

- To change a message, press the programmed message that you want to change.

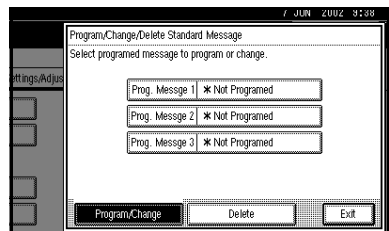

- 2** Enter your message, and press [OK].

Return to the initial display.

 **Reference**

See “Entering Text” in the General Settings Guide.

 **Note**

- To program another message, repeat from step 1.

Deleting Standard Messages

Use this function to delete programmed messages that you no longer need.

Press the **[User Tools/Counter/Inquiry]** key. See p.7 “Control Panel”, *Facsimile Reference (option) <Basic Features>*. And then press **[Facsimile Features] ⇒ [Prog./Change/Delete] ⇒ [Program/Change/Delete Standard Message]**.

- 1** Press [Delete], and then select the message that you want to delete.

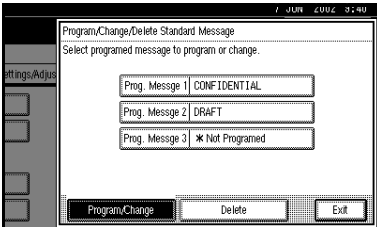

- 2** Press [Delete].

 **Note**

- To delete another message, repeat from step 1.

- 3** Press [Exit].

Return to the initial display.

Storing and Changing an Auto Document

If you often have to send a particular page to people (for example, a map, a standard attachment, or a set of instructions), you can store that page in memory as an Auto Document. This saves rescanning the original every time you wish to send it.

Use the following procedure to program a new Auto Document or overwrite an existing one.

You can store the following items in an Auto Document:

- You can store up to 6 Auto Documents (18 with the optional Expansion Memory installed). Each Auto Document can contain one page.
- Originals (Max 6 Documents; when the optional Fax Function Upgrade Unit is installed, maximum 18 documents, only one page per file).
- Scan settings (Resolution, Original Type, and Image Density)
- Irregular Scan Area
- Document name (up to 16 characters)

 **Important**

- We recommend that you print the Auto Document list and keep it when you program or change an Auto Document. See p.101 “Reports/Lists”.

Press the **[User Tools/Counter/Inquiry]** key. See p.7 “Control Panel”, *Facsimile Reference (option) <Basic Features>*. And then press **[Facsimile Features] ⇒ [Prog./Change/Delete] ⇒ [Store/Change/Delete Auto Document]**.

- 1 Select the file you want to store or change.

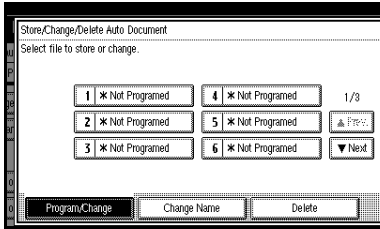

Note

- If there are stored files, the file names are shown.

Storing a file

- 1 Select [***Not programed**].
- 2 Enter a file name, and then press [**OK**].

Note

- You should program the file name.

Reference

See "Entering Text" in the General Settings Guide.

Changing a file

- 1 Select a file you want to change.
The message "A file is already stored. If another file is stored, previous one will be deleted. Is it OK?" is shown.
- 2 Press [**Store**].

Changing only a file name

- 1 Press [**Change Name**].
- 2 Select a file you want to change.

- 3 Enter a file name, and then press [**OK**].
Go to step 4.

Reference

See "Entering Text" in the General Settings Guide.

- 2 Place your original on the Document Feeder or the Exposure Glass and select any scan settings you require.

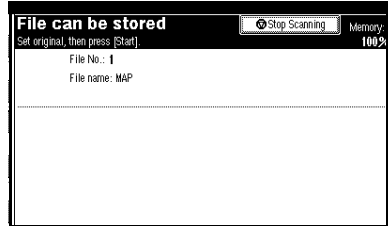

Note

- You can also specify a Scan Size. See p.16 "Setting a Scan Area", *Facsimile Reference (option) <Basic Features>*.

- 3 Press the [**Start**] key.
The machine starts to scan.

Note

- To cancel scanning, press [**Stop Scanning**].

- 4 Press [**Exit**] after scanning is finished.
Return to the initial display.

Deleting an Auto Document

Note

- ❑ You cannot delete an Auto Document waiting to be transmitted. Delete it after the transmission or cancel the transmission, and then delete the Auto Document.

Press the **[User Tools/Counter/Inquiry]** key. See p.7 “Control Panel”, *Facsimile Reference (option) <Basic Features>*. And then press **[Facsimile Features] ⇒ [Prog./Change/Delete] ⇒ [Store/Change/Delete Auto Document]**.

- 1 Press **[Delete]**, and select the message you want to delete.

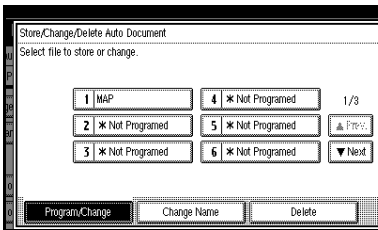

- 2 Press **[Delete]**.

- 3 Press **[Exit]**.

The initial display is shown.

Programming and Changing a Scan Size

When you select a Scan Size to scan a non-standard size original, two custom sizes of original are available (Program Size 1 and Program Size 2). Use these functions to program a custom size in advance.

To change an existing Scan Size, just use the same procedure.

Important

- ❑ When programming or changing a Scan Size, we recommend that you make a memo of the new size.

Note

- ❑ You can specify a horizontal length from 128 to 1,200mm or from 5.5 to 47 inches.

Press the **[User Tools/Counter/Inquiry]** key. See p.7 “Control Panel”, *Facsimile Reference (option) <Basic Features>*. And then press **[Facsimile Features] ⇒ [Prog./Change/Delete] ⇒ [Program/Change/Delete Scan Size]**.

- 1 After confirming **[Register/Change]** is selected, press **[Program Size 1]** or **[Program Size 2]**.

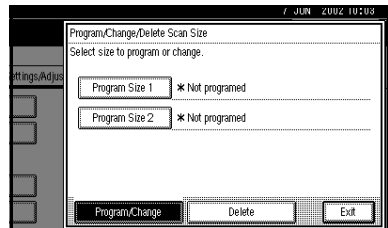

2 Enter a horizontal size with the number keys.

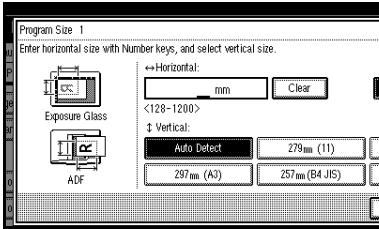

Note

- You can specify a horizontal length from 128 to 1,200mm or from 5.5 to 47 inches. You cannot specify a length shorter than 128mm or longer than 1,200 mm.
- Each time you press [mm] or [inch], the units change between “mm” and “inch” alternately. If you enter a length and change the unit by pressing [mm] or [inch], the length is converted automatically according to the unit (fractions are rounded off). For Example, When you enter **[2]**, **[5]** and **[0]** in millimeters and change to “inch”, the length “9.8inch” is shown on the display. If you press [mm] or [inch] again, “249mm” is displayed.
- If you make a mistake, press [Clear] or the [Clear/Stop] key and try again.

3 Select a vertical size.

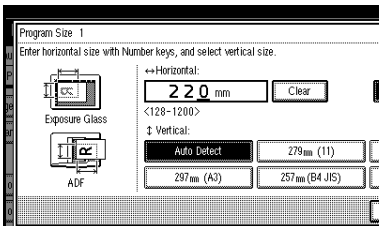

Note

- A displayed vertical size differs depending on the selected unit. When [mm] is selected, [Auto Detect], [210mm (A4)], [257mm(B4 JIS)], [297mm (A3)], [216mm (8 1/2)] and [279mm (11)] are shown. When [inch] is selected, [Auto Detect], [8.3inch (A4)], [10.1inch(B4 JIS)], [11.7inch (A3)], [8.5inch] and [11.0inch] are shown.

4 Press [OK].

5 Press [Exit].

Return to the initial display.

Deleting a Scan Size

Press the [User Tools/Counter/Inquiry] key. See p.7 “Control Panel”, *Facsimile Reference (option) <Basic Features>*. And then press [Facsimile Features] ⇒ [Prog./Change/Delete] ⇒ [Program/Change/Delete Scan Size].

1 Press [Delete], and select [Program Size 1] or [Program Size 2].

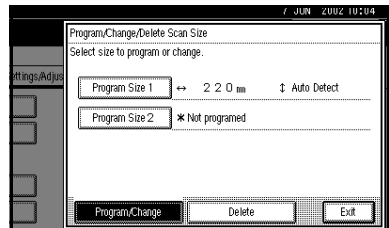

2 Press [Yes].

3 Press [Exit].

Return to the initial display.

Reports/Lists

This function allows you to print the following reports and lists manually. Select a report or list as needed.

- Journal
See p.19 "Printing the Journal".
- Quick Dial list
See p.40 "Quick Dial", *Facsimile Reference (option) <Basic Features>*.
- Label Insertion list
See p.40 "Quick Dial", *Facsimile Reference (option) <Basic Features>*.
- Group Dial list
See p.44 "Groups", *Facsimile Reference (option) <Basic Features>*.
- Program list
See p.81 "Programs".
- Auto Document list
See p.97 "Storing and Changing an Auto Document".

Press the **[User Tools/Counter/Inquiry]** key. See p.7 "Control Panel", *Facsimile Reference (option) <Basic Features>*. And then press **[Facsimile Features]** ⇒ **[Print List/Report]**.

1 Select a list or report you want to print.

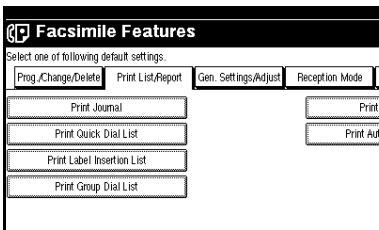

Note

- When printing the Journal, you can select a printing mode from **[All]**, **[Print per File No.]**, or **[Print per User Code]**.

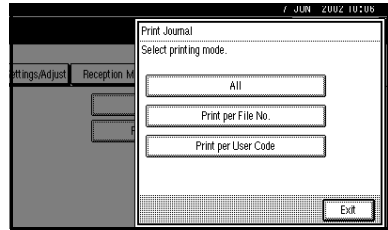

- When printing the Quick Dial list, you can select from **[Print per Programming No.]**, **[Print Title 1]**, **[Print Title 2]** or **[Print Title 3]**.

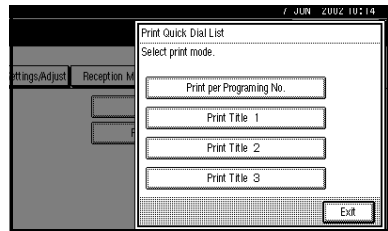

2 Press the **[Start]** key.

Return to the initial display.

Note

- To cancel printing, press **[Cancel]**. The display will return to step **1**.

General Settings/Adjustment

Make the settings for the following items. The set items are highlighted on the Facsimile Features menu when the power is turned on.

❖ **Switch Memory/Immed. Transmission**
Use this function for specifying the Transmission Mode for document transmission.

❖ **Text Size Priority**
Use this function to specify the character size of your originals for scanning.

❖ **Original Type Priority**
Use this function for specifying the type of originals for scanning.

❖ **Auto Image Density**
Use this function for specifying whether to prioritize automatic Image Density for scanning your originals.

❖ **Adjust Scan Density**
Use this function for specifying the scan density of your originals.

❖ **Switch Title of Quick Dial Table**
Use this function for selecting the title to be shown on the Quick Dial Table.

❖ **Switch Display**
Use this function for displaying the number keys instead of the Quick Dial Table.

❖ **Adjust Sound Volume**
See p.51 "Adjusting Volume", *Facsimile Reference (option) <Basic Features>*.

❖ **Program Fax Information**
See p.37 "Initial Settings and Adjustments", *Facsimile Reference (option) <Basic Features>*.

❖ **Fax Header Print Setting**
Use this function for specifying whether to print the Fax Header.

❖ **Label Insertion Priority Setting**
Use this function for specifying whether to use the Label Insertion function.

❖ **Reduced Image TX Setting**
Use this function for specifying whether to use reduced image transmission. See p.53 "Transmission Options".

❖ **Auto Reduced Image Setting**
Use this function for specifying whether to transmit an automatically reduced image. See p.53 "Transmission Options".

❖ **Closed Network Priority Setting**
Use this function for specifying whether to execute ID transmission. See p.53 "Transmission Options".

❖ **Scan End Reset**
Use this function for specifying whether to return to the initial settings each time an original is scanned.

❖ **TX Stamp Priority**
Use this function for specifying whether to press a TX stamp.

❖ **Line Priority Setting**
Use this function for specifying the line of usage.

Note

- The display may differ depending on the line type you have.

◆ Program Economy Time

Use this function for specifying a time for transmission when the telecommunication rates are low. See p.5 "Sending at a Specific Time (Send Later)".

● Limitation

- You can program only one Economy Time.

◆ On Hook Mode Release Time

Use this function for specifying the time to cancel the On Hook mode after you transmit with On Hook dialing. It is convenient to use this when the Fax Information service disconnects your On Hook dialing.

◆ Quick Operation Key

Frequently used functions that are programmed as Quick Operation Keys are shown on the menu immediately after the power is turned on.

The Quick Operation Keys can be programmed with the following functions.

Journal, TX File Status, Print Conf. RX, Print Memory Lock, Stored File, Send Later, Auto Document, 2 Sided Original, Closed Network, Polling TX, Polling RX, Fax Header Print, Label Insertion, Dest. Management, Forwarding, Transfer Request

Up to three functions can be programmed in Quick Operation Keys.

Note

- The functions that are dimmed have already been set.

Press the **[User Tools/Counter/Inquiry]** key. See p.7 "Control Panel", *Facsimile Reference (option) <Basic Features>*. And then press **[Facsimile Features]** ⇒ **[Gen. Settings/Adjust]**.

- 1** Select a function you want to specify.

Facsimile Features		
Select one of following default settings:		
Prog./Change/Delete	Print List/Report	Gen. Settings/Adjust
Reception Mode		
Memory/Inmed. Transmission Switch	Memory Transmission	Switch Title
Text Size Priority	Standard	Swi
Original Type Priority	Text	Adjust
Auto Image Density	ON	Program
Adjust Scan Density	Level 4	

Note

- If you make a mistake, press **[Clear]** or the **[Clear/Stop]** key and try again.

- 2** Press **[OK]** after making any function settings.

After the settings/adjustment are finished, return to the initial display.

Reception Mode

Make settings for the following reception functions.

- Switch Reception Mode
See p.67 "Reception Functions".
See p.36 "Selecting the Reception Mode", *Facsimile Reference (option)* <Basic Features>.
- Authorized RX
See p.118 "Authorized Reception".
- Forwarding
See p.118 "Forwarding".
- RX File Print Qty
See p.72 "Multi-copy Reception".
- 2-Sided Print
See p.71 "2-Sided Printing".
- RX Reverse Printing
See p.74 "Reverse Order Printing".
- Paper Tray
- G3/G4 Separate Tray
See p.79 "G3/G4 Separate Tray".
- Checkered Mark
See p.70 "Checkered Mark".
- Center Mark
See p.70 "Center Mark".
- Print Reception Time
See p.71 "Reception Time".
- FAX Print Color
See p.75 "FAX Print Color".
- 2nd Color Choice
See p.75 "2nd Color Choice".

Note

- In the "RX File Print Qty" setting, the range of available print quantities is 1 to 10.
- When no tray is specified for "Paper Tray" setting, "Auto Select" will be selected.

- If you want to select the bypass tray for "Paper Tray" setting, specify it with "Special Sender" by "Special Senders to Treat Differently". See p.117 "Special Senders to Treat Differently".
- If the paper type is set to **[Thick paper]** or **[OHP]** for "Paper Tray" setting, papers in the tray will not be used for printing. See p.78 "The trays that cannot be used for printing fax documents".
- If you select "OFF" for the "G3/G4 Separate Tray" setting, the received faxes are delivered to the default tray.
- In the "2nd Color Choice" setting, the color specified for FAX Print Color can not be used as a 2nd Color Choice.
- If the machine has run out of the color that selected as the 2nd Color, there is no additional substitution.

Press the **[User Tools/Counter/Inquiry]** keys. See p.7 "Control Panel", *Facsimile Reference (option)* <Basic Features>. And then press **[Facsimile Features]** ⇒ **[Reception Mode]**.

- 1** Select a function you want to specify.

Facsimile Features		
Select one of following default settings.		
Prog./Change/Delete	Print List/Report	Gen. Settings/Adjust
Switch Reception Mode	Auto reception	2 S
		RX/Rp
Authorized RX	OFF	P
Forwarding	OFF	G3/G4
RX File Print Qty	1 set(s)	

Note

- If you make a mistake, press **[Clear]** or the **[Clear/Stop]** key and try again.

2 Press [OK] after making any function setting.

After the settings are finished, return to the initial display.

8. Key Operator Setting

Function List

Function name	Description	Reference
Transmission Page Count	Check the transmission and reception, and totals on the display.	See p.109 "Counters".
Forwarding	Transfers received messages to a registered receiver (forwarding destination).	See p.109 "Forwarding".
Memory Lock Reception	Switch the Memory Lock to on or off. To use it, register an ID for printing a message received in Memory Lock mode.	See p.111 "Memory Lock".
ECM	If a part of the transmission fails due to a telephone line fault, this function resends the failed part automatically.	See p.112 "ECM".
Parameter Setting	Allows you to change and print the function settings to meet your needs.	See p.113 "Changing the User Parameters".
Program Special Sender	By programming particular receivers as Special Sender in advance, you can have the Special Senders to treated differently.	See p.120 "Programming / Changing Special Senders".
Box Setting	By using SUB and SEP Codes with these functions, you can send messages to another party's box and retrieve messages stored in boxes.	See p.124 "Box Settings".
Transfer Report	Before using Transfer Request, you need this Transfer Report setting.	See p.131 "Transfer Report".
Program Confidential ID	Register an ID required for Confidential communication.	See p.132 "Programming a Confidential ID".
Program Polling ID	Register an ID required for Polling communication.	See p.133 "Programming a Polling ID".
Program Memory Lock ID	Register an ID required for Memory Lock reception.	See p.133 "Programming a Memory Lock ID".

Function name	Description	Reference
Select Dial/Push Phone	Select a line type when you connect the machine to G3 analog line.  Note <input type="checkbox"/> This function is not available in some areas.	See p.134 "Selecting Dial/Push Phone".
Program ISDN-G3 Line	Program Own Fax Numbers, and sub-addresses when you connect the machine to ISDN.	See p.134 "Programming ISDN G3 Line".
Program ISDN-G4 Line	Program your Own Fax Number, TID (Terminal ID) and sub-address when you connect the machine to a G4 digital line.	See p.135 "Programming ISDN G4 Line".

Using Key Operator Settings

Counters

This function allows you to check the total number of pages transmitted and received on the display.

- **Transmissions:**
Total number of transmitted pages
- **Receptions:**
Total number of received pages

Press the **[User Tools/Counter/Inquiry]** key. See p.7 “Control Panel”, *Facsimile Reference (option) <Basic Features>*. And then press **[Facsimile Features] ⇒ [Key Operator Tools] ⇒ [Transmission Page Count]**. After checking the display, press **[Exit]**.

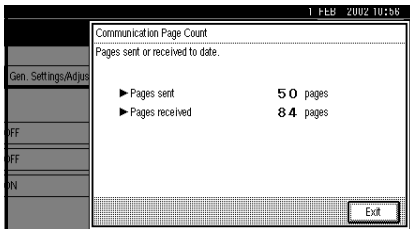

Forwarding

Using this function, you can select messages from Specified Senders to be printed on your machine, and then sent on to another fax machine.

This is useful if, for example, you are visiting another office and would like a copy of your messages sent to that office so you can read them.

Preparation

To use this function, set the Forwarding function in “Reception Mode” to “ON (enable).”

Limitation

- The Forwarding function does not forward messages received with Confidential Reception, Memory Lock, Polling Reception mode, or messages received by Transfer Request.
- You can program senders with Quick Dial Table and Groups. You cannot program a sender with a Group that has destinations specified as Transfer Stations.

Reference

See p.40 “Quick Dial”, *Facsimile Reference (option) <Basic Features>*.

See p.44 “Groups”, *Facsimile Reference (option) <Basic Features>*.

Note

- If you don't program a forwarding station when setting the Forwarding function in the “Reception Mode” to “ON”, the machine prints only received messages without forwarding.

- ❑ If you want to change end receivers separately according to senders, specify end receivers for each special sender in “Special Senders to Treat Differently.” Received messages from unspecified senders will be forwarded to the end receiver specified here. See p.117 “Special Senders to Treat Differently”.
- ❑ One receiver can be specified with this function. For multiple receivers, use Group Dial. See p.44 “Groups”, *Facsimile Reference (option)* <Basic Features>.
- ❑ You can print a Forwarding Mark on messages that are forwarded. See p.113 “Changing the User Parameters” (Switch02, Bit0).
- ❑ You can specify whether or not to print forwarded messages. See p.113 “Changing the User Parameters” (Switch11, Bit6).
- ❑ You can change a Forwarding Station in the same way as you program it.

8

Programming Forwarding Stations

Press the **[User Tools/Counter/Inquiry]** key. See p.7 “Control Panel”, *Facsimile Reference (option)* <Basic Features>. And then press **[Facsimile Features]** ⇒ **[Key Operator Tools]** ⇒ **[Forwarding]**.

1 Press [ON].

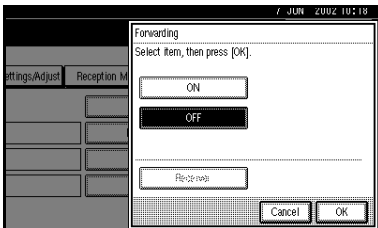

Note

- ❑ If there is a Forwarding Station already programmed, a receiver name is shown. If you want to change the receiver, press **[Receiver]** and go to step 2.

2 Specify the senders with Quick Dial Table, and press [OK].

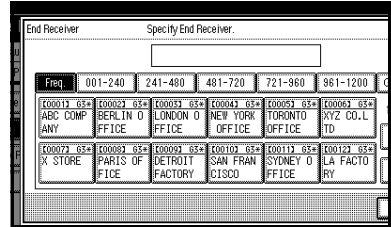

If you make a mistake, press **[Clear]** or the **[Clear/Stop]** key and try again.

3 Press [OK].

Return to the initial display.

Deleting a Forwarding Station

Press the **[User Tools/Counter/Inquiry]** key. See p.7 “Control Panel”, *Facsimile Reference (option)* <Basic Features>. And then press **[Facsimile Features]** ⇒ **[Key Operator Tools]** ⇒ **[Forwarding]**.

1 Press [OFF].

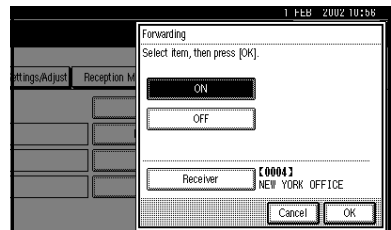

2 Press [OK].

Return to the initial display.

Forwarding Mark

You can print a Forwarding Mark on the receiver's messages which have been forwarded.

The receiver can distinguish between forwarded messages and usual receptions.

Note

- You can specify whether or not to print a Forwarding Mark in the User Parameters. See p.113 "Changing the User Parameters" (Switch02, Bit0).

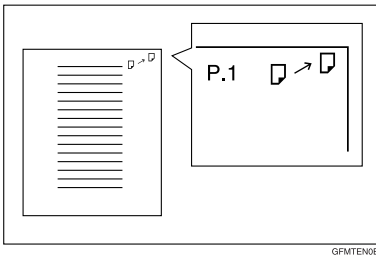

GFM7ENGE

Memory Lock

When you switch Memory Lock on, received messages are stored in memory and are not printed automatically. When a message is received in the Memory Lock mode, the Confidential File (☑) indicator blinks. To print this message, enter the Memory Lock ID. A user without the ID cannot print the message. This prevents an unauthorized person from seeing the message.

Preparation

To use Memory Lock, program the Memory Lock ID and then switch Memory Lock on. See p.133 "Programming a Memory Lock ID".

Note

- To store incoming documents from Special Senders only in Memory Lock, program each sender with "Special Senders to Treat Differently". See p.117 "Special Senders to Treat Differently".

Press the **[User Tools/Counter/Inquiry]** key. See p.7 "Control Panel", *Facsimile Reference (option)* <Basic Features>. And then press **[Facsimile Features]** ⇒ **[Key Operator Tools]** ⇒ **[Memory Lock RX]**.

- 1** Select **[ON]** or **[OFF]**.

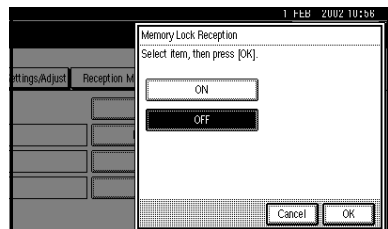

- 2** Press **[OK]**.

Return to the initial display.

ECM

If a part of a transmission fails because of a line problem, the lost data is automatically resent. For this function to work, the other machine must have ECM. You can turn this function on or off with the following procedure.

Note

- If you turn ECM off, you cannot use the following functions:
 - JBIG Transmission
 - Super G3 Communication

Press the **[User Tools/Counter/Inquiry]** key. See p.7 “Control Panel”, *Facsimile Reference (option) <Basic Features>*. And then press **[Facsimile Features]** ⇒ **[Key Operator Tools]** ⇒ **[ECM]**.

1 Select **[ON]** or **[OFF]**.

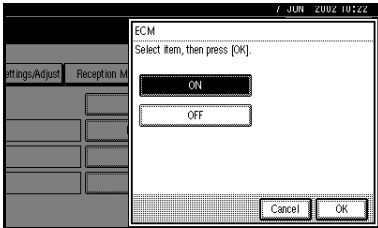

2 Press **[OK]**.

Return to the initial display.

Changing the User Parameters

The User Parameters allow you to customize various settings to suit your needs. To change the function settings, set the User Parameter Switches.

Preparation

Access to some User Parameter Settings requires the installation of optional equipment or that other settings be made beforehand.

Switches and Bits

User Parameters are divided into switches and each switch is divided into eight bits. The right most bit is bit 0 and the left most is bit 7.

Switch 02	0	0	1	1	1	0	1	1
	↓	↓	↓	↓	↓	↓	↓	↓
	7	6	5	4	3	2	1	0

User Parameter List

The User Parameter Switches are outlined below.

Switch	Bit	Item	0	1
02	0	Forwarding Mark	Off	On
	3	TSI Print	Off	On
	5	CIL Print	Off	On
	6	TID Print	Off	On
03	0	Automatic printing of the Memory TX Result Report	Off	On
	2	Automatic printing of the Memory Storage Report	Off	On
	3	Automatic printing of the Polling RX Reserve Report	Off	On
	4	Automatic printing of the Polling RX Result Report	Off	On
	5	Automatic printing of the Immediate TX Result Report	Off	On
	6	Automatic printing of the Polling TX Clear Report	Off	On
	7	Automatic printing of the Journal	Off	On

Switch	Bit	Item	0	1
04	0	Automatic printing of the Confidential File Report	Off	On
	7	Include a portion of the image on the Transmission Result Report (Memory Transmission), Memory Storage Report, Communication Failure Report, or Transfer Result Report (Inclusion of part of image)	Off	On
05	0	Receive Service Call (SC) Condition (Substitute Reception during service call)	Possible (Substitute RX)	Not possible (Reception off)
	2, 1	Substitute the reception when the machine cannot print (Because all the paper trays have run out of paper, toner is empty, or all the paper trays are out of commission) 00: Enabled unconditionally (Free) 01: Enabled when Own Name/Own Fax Number is received 10: Enabled for Polling ID match 11: Disabled (Reception off)		
	5	Just Size Printing	Off	On
	7	Empty cassette alert (Paper Empty Warning indication)	Off	On
06	6	First page scanned for book originals	From the left page	From the right page
07	2	Parallel Memory Transmission	Off	On
08	2	Authorized Reception type	Only receive from specified senders	Receive all messages except those from specified senders
10	1	Combine 2 Originals	Off	On
	3	Page Reduction when printing	Off	On
11	1	Send PB/UUI to ISDN	UUI	PB
	6	Local Print when Forwarding	Off	On
	7	Polling file after sending (Polling transmission standby time)	Delete (Use Once)	Standby (Save)
14	0	Print documents received with Auto Power-On Reception (Night Printing mode)	Immediate printing (Off)	When turning on the operation switch (On)
	1	Long Document Transmission (Well Log)	Off	On
	2	Batch Transmission	Off	On
	3	Reset when function changed	Off	On
	7	System Parameter List TX	Off	On

Switch	Bit	Item	0	1
15	7	Give priority in paper feed from the Large Capacity Tray (LCT)	Off	On
17	2	Whether you need to press Add after entering a Quick Dial/Group Dial when broadcasting	Not Necessary	Necessary
	7	Receive messages by pressing the 【Start】 key when originals are not set	Off (The machine does not receive messages by pressing the 【Start】 key.)	On (The machine receives messages by pressing the 【Start】 key.)
18	0	Print data with Fax Header	Off	On
	1	Print transmitter origin with Fax Header	Off	On
	2	Print file number with Fax Header	Off	On
	3	Print page number with Fax Header	Off	On
19	0	Use paper delivery shift function (Offset Print)	Off	On
	1	Sort Journal by line type	Off	On
20	0	Automatic printing of the PC FAX (LAN FAX) Error Report	Off	On
	1	Reprint the documents that fail to print from LAN FAX driver	Off	On
	5, 4, 3, 2	Store the documents in memory that could not be printed from the LAN FAX driver 0000: 0 minute / 0001: 1 minutes / 0010: 2 minutes / 0011: 3 minutes / 0100: 4 minutes / 0101: 5 minutes / 0110: 6 minutes / 0111: 7 minutes / 1000: 8 minutes / 1001: 9 minutes / 1010: 10 minutes / 1011: 11 minutes / 1100: 12 minutes / 1101: 13 minutes / 1110: 14 minutes / 1111: 15 minutes		
24	1, 0	Store a message in memory that could not be transmitted 00: Off, 01: Store for 24 hours, 11: Store for 72 hours		
25	4	RDS	Off	On

Changing the User Parameters

Important

- We recommend that you print and keep User Parameter list when you program or change a User Parameter. See p.116 “Printing the User Parameter List”.
- Do not change any bit switches other than those shown on the previous pages.

Press the **[User Tools/Counter/Inquiry]** key. See p.7 “Control Panel”, *Facsimile Reference (option) <Basic Features>*. And then press **[Facsimile Features]** ⇒ **[Key Operator Tools]** ⇒ **[Parameter Setting]**.

- 1** Select the Switch number you want to change.

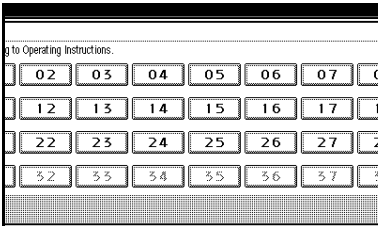

- 2** Select the Bit number you want to change.

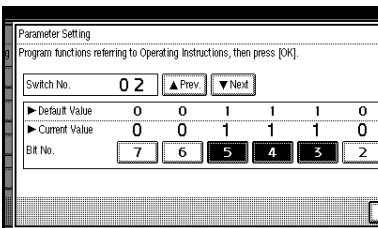

When the Bit number is pressed, the current value switches between 1 and 0.

Note

- Repeat from step **2** to change another Bit number for the same Switch.

- 3** Press **[OK]**.

- 4** Repeat steps **2** and **3** to change the Switch settings.

- 5** After all the settings are finished, press **[Exit]**.
Return to the initial display.

Printing the User Parameter List

Print this list to see the current User Parameter settings.

Press the **[User Tools/Counter/Inquiry]** key. See p.7 “Control Panel”, *Facsimile Reference (option) <Basic Features>*. And then press **[Facsimile Features]** ⇒ **[Key Operator Tools]**.

- 1** Press **[Print List]** next to **[Parameter Setting]**.

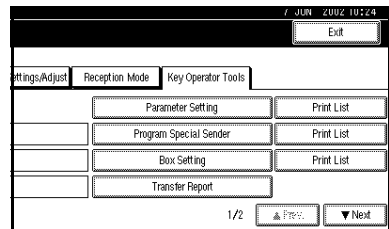

- 2** Press the **[Start]** key.

Return to the initial display.

Note

- To cancel printing a list, press **[Cancel]**. The display will return to step **1**.

Special Senders to Treat Differently

By programming particular receivers in advance, you can set the following function for each receiver.

- Authorized RX
- Forwarding
- Reception File Print Qty
- Print 2 sided
- Memory Lock
- RX Reverse Printing
- Paper Tray

Use the Own Name or Own Fax Number to program your receivers. If the receiver has the same machine make, program an Own Name that is already programmed as a receiver. If the machine is not the same make, use Own Fax Number. To transmit with G4 line, program the information about the destination with G4 lines. For convenience you can specify a function for all programmed numbers. Use the Special Sender registration function to custom set functions for a particular individual.

The following items can be programmed.

- Special Senders (Up to 30. A maximum of 50 when the optional Fax Function Upgrade Unit is installed. A maximum of 20 characters for each name when using G3, and a maximum of 24 characters for each name when using G4.)
- Full/ Partial agreement
When you program Own Names and Facsimile Names for multiple destinations, you can program a common sequence of characters to identify destinations using Partial agreement.

◆ Using a Full agreement

Destination to be registered (Own Name)	Number of registered identifications
NEW YORK BRANCH HONG KONG BRANCH SYDNEY BRANCH	3

◆ Using a Partial agreement

Destination to be registered (Own Name)	Number of registered identifications
BRANCH	1

Note

- You can program up to 30 wild cards (50 with the optional Fax Function Upgrade unit).
- Ignore spaces when comparing identifications.
- You can use wild cards for the following functions:
 - See p.120 “Programming / Changing Special Senders”.
 - See p.120 “Authorized RX”.
 - See p.120 “Forwarding”.

Limitation

- You cannot program senders as Special Senders if they do not have Own Name or Own Fax Number programmed.
- The machine cannot differentiate between Polling Reception and Free Polling documents from Special Senders.

Note

- You can program up to 24 characters for the sender.

- You can check Own Name and Own Fax Number with Journal. You can check programmed Special Senders with specified sender list. See p.19 "Printing the Journal". See p.124 "Printing the Special Sender List".
- If you select "OFF" for the Special Sender function in "Initial Set Up", the settings will be the same as the "Reception Mode" settings. See p.104 "Reception Mode".

◆ Authorized Reception

Use this function to limit incoming senders. The machine only receives the faxes from programmed Special Senders, and therefore, it helps you screen out unwanted messages, such as junk mail, and save you from wasting fax paper.

Note

- To use this function, program the Special Senders function, and then select "ON" in "Authorized RX" with "Reception Mode". See p.104 "Reception Mode". See p.113 "Changing the User Parameters" (Switch08, Bit2).
- Without programming Special Senders, the Authorized RX function will not work even if you select "ON".
- You can select whether to receive only from programmed senders or receive only from senders other than the ones programmed with "User Parameters". See p.113 "Changing the User Parameters" (Switch08, Bit2).

- If you select "OFF" for Authorized RX in "Initial Set Up", the settings will be the same as the "Reception Mode" settings. See p.104 "Reception Mode".
- You can change Special Senders in the same way as you program them.

◆ Forwarding

Use this function to print received messages, and then transfer them to receivers which are programmed beforehand. Only faxes sent by programmed senders (Special Senders) will be received. Thus, paper will not be wasted for printing unnecessary faxes. Receiving faxes sent only by senders not programmed as Special Senders is also possible.

Note

- To use this function, program your Special Senders, and then select "ON" for "Forwarding" in "Reception Mode". See p.104 "Reception Mode".
- If you specify "ON" in "Forwarding" and select "Same as basic settings", the fax message will be forwarded to the other ends programmed in "Specify End Receiver". See p.109 "Forwarding".
- If you do not program any Special Senders, the machine transfers all incoming documents to the other end that is specified in "Specify end Receiver".

◆ Reception File Print Quantity

Use this function to print the specified number of copies of documents received from programmed senders (Special Senders). If you do not program any Special Senders, the machine prints the Specified number of copies for all received documents.

● Limitation

- ❑ You cannot use multi-copy printing with Polling Reception, Confidential Reception, or Memory Lock.

📝 Note

- ❑ You can specify 1 to 10 copies.

◆ Print 2 Sided

The optional duplex unit is required.

Use this function to print on both sides of the paper.

● Limitation

- ❑ If you select bypass tray for the "Paper Tray", duplex printing is disabled.

◆ Memory Lock

Use this function to store incoming documents from programmed senders (Special Senders) in memory without printing them. People who do not know the Memory Lock ID cannot print the documents, and therefore this function is useful for receiving confidential documents. If you do not program any senders, the machine receives fax message from all senders using Memory Lock reception.

🔍 Reference

See p.133 "Programming a Memory Lock ID".

● Limitation

- ❑ If you program the same sender in Memory Lock and Forwarding, Forwarding is disabled.

◆ Reception Reverse Printing

Use this function to print the pages in Reverse Order. See p.74 "Reverse Order Printing".

◆ Paper Tray

Use this function to print the documents received from programmed senders (Special Senders) and the documents from other senders on different types of paper.

For example, if blue paper is in tray 1 and white paper is in tray 2, the machine prints the documents from Special Senders on the blue paper and prints the documents from other senders on the white paper, making it easy for you to differentiate between the two.

If you do not program any Special Senders, the machine outputs the documents received from all senders using the default paper tray.

● Limitation

- ❑ For Polling Reception and Free Polling, you cannot select the paper tray.
- ❑ Paper in the bypass tray, specified as the paper tray, will be delivered to the machine's output tray, even if the optional Finisher Unit has been set as the output tray.
- ❑ If the paper type is set to **[Thick paper]** or **[OHP]**, papers in the tray will not be used for printing. See p.78 "The trays that cannot be used for printing fax documents".

Note

- If the machine receives a message that is a different size from the paper in the specified tray, the machine prints the message after splitting it or minimizing its size. See p.73 “Page Separation and Length Reduction”.
- Selection of the bypass tray (optional) enables you to specify the paper size in “Scan Area”.

Programming/Changing Special Senders

Press the **[User Tools/Counter/Inquiry]** key. See p.7 “Control Panel”, *Facsimile Reference (option)* <Basic Features>. And then press **[Facsimile Features]** ⇒ **[Key Operator Tools]** ⇒ **[Program Special Sender]**.

1 Select destination to program.

When programming a new destination, press “*Not Programed”.

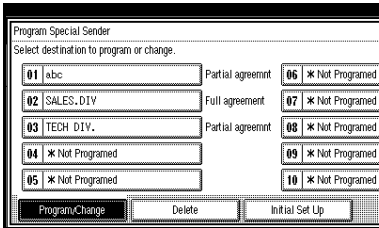
**2** Enter a destination, and then press [OK].

Enter a destination using Own Name or Own Fax Number.

Reference

See “Entering Text” in the General Settings Guide.

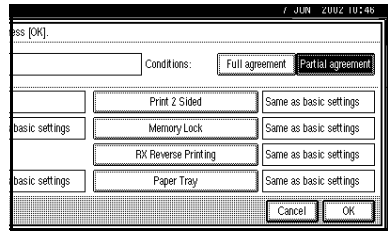
3 When programming the condition, press [Full agreement] or [Partial agreement].**4** Select the item you want to program.**Note**

- You must select only the item you want to program.
- If you select **[Same as basic settings]**, the settings will be the same as **[Reception Mode]**. (See p.104 “Reception Mode”), **[Forwarding]** (See p.109 “Forwarding”) and **[Memory Lock]** (See p.111 “Memory Lock”).
- To cancel these settings, press **[Cancel]**. The display will return to step **1**.

Authorized RX

- 1** Press **[Authorized RX]**.
- 2** Select **[ON]** or **[OFF]**.
- 3** Press **[OK]**.

Forwarding

- 1** Press **[Forwarding]**.
- 2** Select **[ON]** or **[OFF]**.
If you select **[OFF]**, go to step **4**.
- 3** Specify an end receiver.

4 Press [OK].

If you select **[Yes]**, the name of the end receiver is shown on the right of "Receiver :".

Reception File Print Qty

1 Press [Reception File Print Qty].**2 Select [Number of Sets].****3 Enter the print quantity with the number keys.****Note**

- If you make a mistake, press **[Clear]** or the **[Clear/Stop]** key and try again.

4 Press [OK].

Print 2 Sided

1 Press [Print 2 Sided].**2 Select [ON] or [OFF].****3 Press [OK].**

Memory Lock

1 Press [Memory Lock].**2 Select [ON] or [OFF].****3 Press [OK].**

RX Reverse Printing

1 Press [RX Reverse Printing].**2 Select [ON] or [OFF].****3 Press [OK].**

Paper Tray

1 Press [Paper Tray].**2 Select the tray you want to use.****Note**

- You can select **[Tray 1]**, **[Tray 2]**, **[Tray 3]**, **[Bypass Tray]** or **[Auto Select]**.

3 Press [OK].**5 Press [OK].**

A Special Sender has been programmed.

Return to the initial display.

Note

- To program another sender, repeat from step **1**.

Programming "Initial Set UP" of a Special Sender

Use this function to program "Initial Set Up" of a Special Sender. You can also specify the Bypass Tray Paper Size.

Press the **[User Tools/Counter/Inquiry]** key. See p.7 "Control Panel", *Facsimile Reference (option)* <Basic Features>. And then press **[Facsimile Features]** ⇒ **[Key Operator Tools]** ⇒ **[Program Special Sender]**.

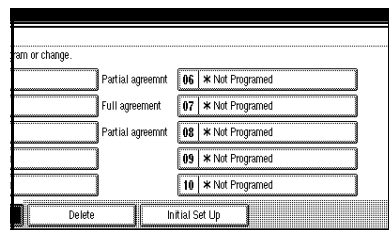
1 Press [Initial Set Up].

2 Select a function you want to program.

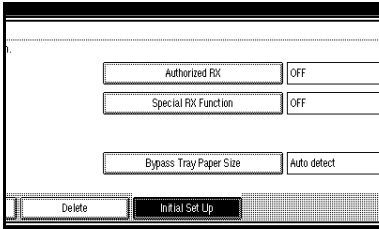

Note

- In this feature, "Authorized RX" has the same settings as "Reception Mode". See p.104 "Reception Mode".

Programming "Authorized RX" and "Special RX Function"

- 1 Select [ON] or [OFF].
- 2 Press [OK].

Programming "Bypass Tray Paper Size"

- 1 Select a size you want to program.

You can select a size from [Auto Detect], [Standard Size] or [Custom Size].

If you select [Auto Detect], go to steps 1 and 8.

If you select [Standard Size], go to steps 1, 2, and 8.

If you select [Custom Size], go to steps 1, and 3 to 8.

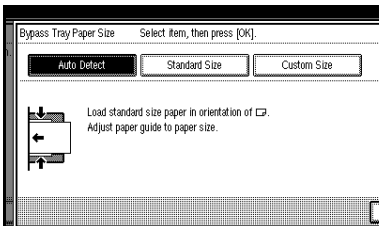

Note

- If you select [Auto Detect], the machine shows a paper size automatically.

- The machine will detect the paper size for the bypass tray as the short edge of the paper is inserted into the machine. Even if you placed a A4 paper on [diagram] direction, the machine will detect it as a A3 [diagram].

- If you select [Standard Size], select a paper size displayed, and then go to step 8.
- If you select [Custom Size], go to step 3.

- 2 Select a size you want to program in the size being shown.

- 3 Make sure that [Vertical] is selected.

Note

- If [Vertical] is not selected, press [Vertical].

- 4 Enter the vertical size of the paper with the number keys.

Note

- You can specify a vertical size from 210 mm (8.3 inch) to 305 mm (12.0 inch). You cannot enter a size smaller than 210 mm or larger than 305mm.

- Each time you press [mm] or [inch], the units change between "millimeter" and "inch" alternately. If you enter a length and change the unit by pressing [mm] or [inch], the length is converted automatically according to the unit (fractions are rounded off).

5 Press [**#**].

The size you selected is shown.

6 Enter the horizontal size of the paper with the number keys.**Note**

- The method to program or change Bypass Tray Paper Size for Copy Function is different from that of Fax Function.
- You can specify a horizontal size from 148 mm (5.8 inch) to 457 mm (18.0 inch). You cannot enter a size smaller than 148 mm or larger than 457 mm.
- Each time you press [**mm**] or [**inch**], the units change between “mm” and “inch” alternately. If you enter a length and change the unit by pressing [**mm**] or [**inch**], the length is converted automatically according to the unit (fractions are rounded off).

7 Press [**#**].

The size you selected is shown.

8 Press [**OK**].**3** Press [**Exit**].

Return to the initial display.

Deleting a Special Sender

Use this function to program “Initial Set Up” of a Special Sender. Also the Bypass Tray Paper Size can be specified.

Press the [**User Tools/Counter/Inquiry**] key. See p.7 “Control Panel”, *Facsimile Reference (option)* <Basic Features>. And then press [**Facsimile Features**] ⇒ [**Key Operator Tools**] ⇒ [**Program Special Sender**].

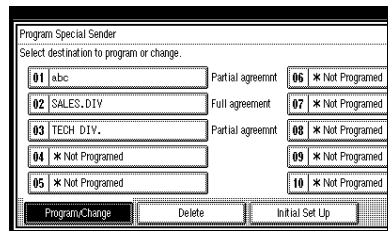
1 Press [**Delete**] and select a Special Sender you want to delete.**2** Press [**Delete**].

A Special Sender is deleted and “*Not Programmed” is shown.

Return to the initial display.

Printing the Special Sender List

Press the **[User Tools/Counter/Inquiry]** key. See p.7 “Control Panel”, *Facsimile Reference (option) <Basic Features>*. And then press **[Facsimile Features]** ⇒ **[Key Operator Tools]**.

1 Press **[Print List]** next to “Program Special Sender”.

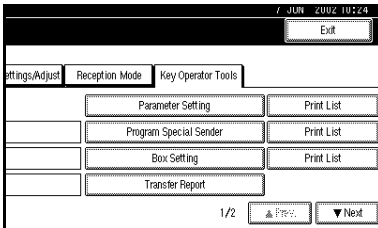

2 Press the **[Start]** key.

Return to the initial display.

Note

- To cancel printing a list, press **[Cancel]**. The display will return to step **1**.

See p.128 “Programming/Editing Transfer Boxes”.

For details about how to print out and delete messages stored in boxes:

See p.27 “Personal Boxes”.

See p.29 “Information Boxes”.

Note

- The combined total of items that can be stored in the Personal Box, Information Box and Transfer Box functions is 150. Installing the optional Fax Function Upgrade Unit increases this capacity to 400 items.
- SUB and SEP Codes can be up to 20 digits long and contain numbers, spaces, pound signs (#), and asterisks (*).

Limitation

- You cannot set the same Box Code on two different boxes.
- Transmission or programming may not be used if there is not enough free memory left. The amount of free memory left is different depending on the optional equipment installed.

Box Settings

The following functions are for delivery and transfer of messages:

- Personal Box
- Information Box
- Transfer Box

By using SUB and SEP Codes with these functions, you can send messages to another party's box and retrieve messages stored in boxes.

For details about how to set up these functions:

See p.124 “Programming/Editing Personal Boxes”.

See p.126 “Programming/Editing Information Boxes”.

Programming/Editing Personal Boxes

This section describes how to program Personal Boxes.

You can store the following items:

- Box Name (required)
Up to 20 characters long
- SUB Code (required)
Up to 20 characters long and can be composed of digits 0-9, “#”, “*” and spaces (the first character cannot be a space).
- Password (optional)
Up to 20 characters long and can be composed of digits 0-9, “#”, “*” and spaces (the first character cannot be a space).

When registering a password, a mark is displayed before the Box Name.

- Receiver (optional)
You can program one delivery destination for each Personal Box. Specify the Quick Dial the delivery destination is stored in.

Note

- The Fax Header is not printed on delivered messages.
- If a message cannot be delivered, a Communication Failure Report is printed and the message is saved as a Confidential Reception document.
- You can edit boxes in the same way you program them. However, to change the SUB Code itself, you must delete the box, and then program a new SUB Code.

Reference

See p.27 “Personal Boxes”.

Press the **[User Tools/Counter/Inquiry]** key. See p.7 “Control Panel”, *Facsimile Reference (option) <Basic Features>*. And then press **[Facsimile Features]** ⇒ **[Key Operator Tools]** ⇒ **[Box Setting]**.

1 Select a box to program.

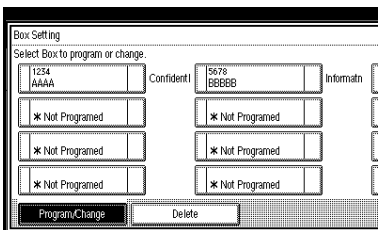

When programming a new box, press “*Not Programed”.

Note

- To change a box already programmed, press it and go to step 4.

2 Press **[Personal Box]**.

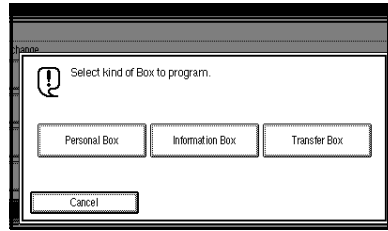

3 Enter a Box Name, and press **[OK]**.

Reference

See “Entering Text” in the General Settings Guide.

4 Enter a SUB Code.

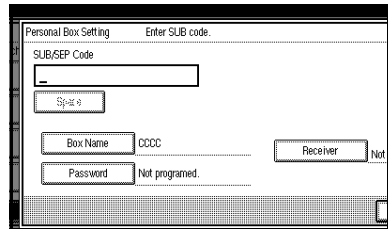

Note

- To change the SUB Code, press **[Clear]** or the **[Clear/Stop]** key and try again. To change Box Name, press **[Box Name]**, and then repeat from step 3.
- If you make a mistake, press **[Clear]** or the **[Clear/Stop]** key and try again.

5 Specify any settings you require.

If you do not program **[Password]** or **[Receiver]**, go to step 3.

Programming a Password

1 Press **[Password]**.

- Enter a password, and then press **[OK]**.

Note

- If you make a mistake, press **[Clear]** or the **[Clear/Stop]** key and try again.

Programming a Receiver

- Press **[Receiver]**.
 - Select a destination with the Quick Dial Table.
 - Press **[OK]**.
- 6** Press **[OK]**.
A box mode is shown next to the box.
- 7** Press **[Exit]**.
Return to the initial display.

Deleting Personal Boxes

This section describes how to delete Personal Boxes.

Limitation

- If messages are programmed in the box, you cannot delete the box.

Press the **[User Tools/Counter/Inquiry]** key. See p.7 “Control Panel”, *Facsimile Reference (option)* <Basic Features>. And then press **[Facsimile Features]** ⇒ **[Key Operator Tools]** ⇒ **[Box Setting]**.

- Press **[Delete]** and select a box you want to delete.

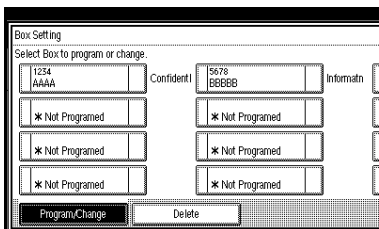

Note

- When selecting a file set with a password, the password input screen is displayed. Enter the password using the number keys and press **[OK]**. If you enter an incorrect number, press **[Clear]** or the **[Clear/Stop]** key to delete the entered numbers. Press **[Cancel]** to cancel file selection.

- Press **[Delete]**.

The box is deleted and “*Not Programed” is shown.

Return to the initial display.

Programming/Editing Information Boxes

This section describes how to set up an Information Box.

You can store the following items:

- Box Name (required)
Up to 20 characters long
- SEP Code (required)
Up to 20 characters long and can be composed of digits 0-9, “#”, “*” and spaces (the first character cannot be a space).
- Password (optional)
Up to 20 characters long and can be composed of digits 0-9, “#”, “*” and spaces (the first character cannot be a space).

When registering a password, a mark is displayed before the Box Name.

Note

- You can edit boxes in the same way you program them. However, to change the SEP Code itself, you must delete the box, and then program a new SEP Code.

Reference

See p.29 “Information Boxes”.

Press the **[User Tools/Counter/Inquiry]** key. See p.7 “Control Panel”, *Facsimile Reference (option)* <Basic Features>. And then press **[Facsimile Features]** ⇒ **[Key Operator Tools]** ⇒ **[Box Setting]**.

1 Select a box to program.

When programming a new box, press “*Not Programed”.

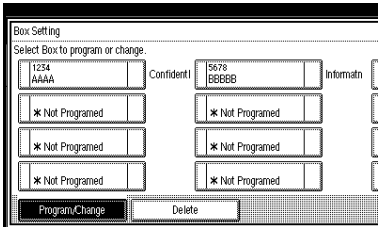

Note

- To change a box already programmed, press it, and then go to step 4.

2 Press [Information Box].

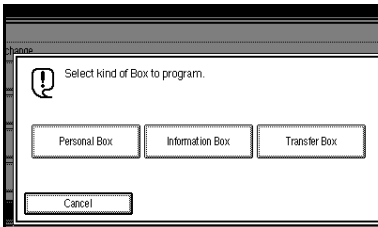

3 Enter a Box Name, and then press [OK].

Reference

See “Entering Text” in the General Settings Guide.

4 Enter a SEP Code.

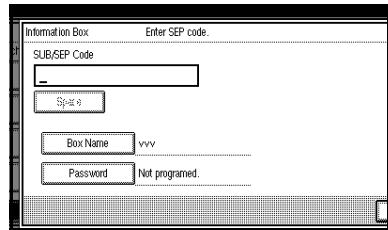

Note

- To change SEP Code, press **[Clear]** or the **[Clear/Stop]** key and try again. To change Box Name, press **[Box Name]**, and then repeat from step 3.
- If you make a mistake, press **[Clear]** or the **[Clear/Stop]** key and try again.

5 Press [Password].

Note

- If you do not want to program a password, go to step 7.

6 Enter a password, and then press [OK].

Note

- If you make a mistake, press **[Clear]** or the **[Clear/Stop]** key and try again.

7 Press [OK].

A box mode is shown next to the box.

8 Press [Exit].

Return to the initial display.

Deleting Information Boxes

This section describes how to delete Information Boxes.

Limitation

- ❑ If messages are programmed in the Information Box, you cannot delete the box.

Press the **[User Tools/Counter/Inquiry]** key. See p.7 “Control Panel”, *Facsimile Reference (option)* <Basic Features>. And then press **[Facsimile Features]** ⇒ **[Key Operator Tools]** ⇒ **[Box Setting]**.

- 1 Press **[Delete]** and select a box you want to delete.

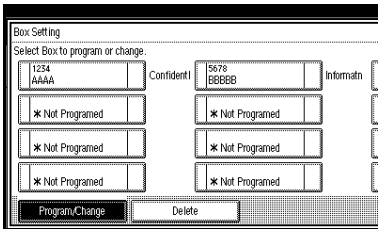

Note

- ❑ When selecting a file set with a password, the password input screen is displayed. Enter the password using the number keys and press **[OK]**. If you enter an incorrect number, press **[Clear]** to delete the entered numbers. Press **[Cancel]** to cancel file selection.

- 2 Press **[Delete]**.

The box is deleted and “*Not Programed” is shown.

Return to the initial display.

Programming/Editing Transfer Boxes

This function turns your machine into a fax relay station. Documents sent with a SUB Code that matches the SUB Code programmed as a Transfer Box are received, and then relayed to the programmed receiver.

Since documents can be sent to multiple destinations in a single Transfer Request, you can economize on communication costs when sending to remote destinations.

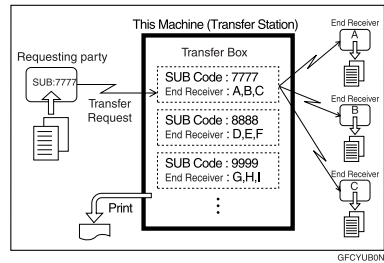

Note

- ❑ Inform the Requesting Party of the SUB Code assigned to the Transfer Box. When they wish to have a message transferred by your machine, ask them to send the message using SUB Code Transmission and specifying this SUB Code. If a password is also programmed, inform them of this too and ask them to enter it for the SID Code.

You can store the following items:

- Box Name (required)
Up to 20 characters long
- SUB (required)
Up to 20 characters long and can be composed of digits 0-9, “#”, “*” and spaces (the first character cannot be a space).

- Password (optional)
Up to 20 characters long and can be composed of digits 0-9, "#", "*" and spaces (the first character cannot be a space).
When registering a password, a mark is displayed before the Box Name.
- Receiving Station (required)
You can store 5 Receiving Stations (destinations to which messages will be forwarded) for each box. Specify Receiving Stations with Quick Dials or Groups assigned to Quick Dials that have been programmed beforehand.

! Limitation

- After messages are transferred, a Transfer Result Report is not sent back to the sender.

📎 Note

- After messages are transferred, they are deleted.
- When this function is turned on, the machine prints out received messages that it transfers and the Transfer Result Report after the transfer has finished. If you want to turn this function off, please contact your service representative.
- When the programmed receiver is a Multi-step Transfer Group Dial, Multi-step Transfer takes place.
- You can edit boxes in the same way you program them. However, to change the SUB Code itself, you must delete the box, and then program a new SUB Code.
- You can edit boxes in the same way you program them.

Press the **[User Tools/Counter/Inquiry]** key. See p.7 "Control Panel", *Facsimile Reference (option) <Basic Features>*. And then press **[Facsimile Features] ⇒ [Key Operator Tools] ⇒ [Box Setting]**.

1 Select a box to program.

When programming a new box, press "*Not Programed".

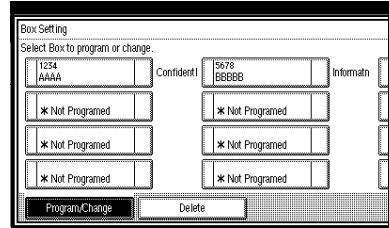

📎 Note

- To change a box already programmed, press it, and then go to step 1.

2 Press [Transfer Box].

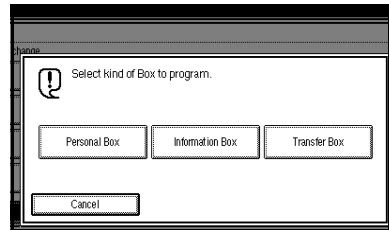

3 Enter a Box Name, and then press [OK].

🔍 Reference

See "Entering Text" in the General Settings Guide.

4 Enter a SUB Code.

Note

- To change SUB Code, press **[Clear]** or the **[Clear/Stop]** key and try again. To change Box Name, press **[Box Name]**, and then repeat from step 3.
- If you make a mistake, press **[Clear]** or the **[Clear/Stop]** key and try again.

5 Specify the condition of registration.

Programming Receiving Stations

1 Select Receiving Station.

Note

- You can store 5 Receiving Stations.

2 Specify Receiving Stations with Quick Dials.

Note

- You can also specify Receiving Stations with Group Dials.

3 Press [OK].

Repeat from step 1 to specify another Receiving Station.

Programming a Password

If you do not want to program a password, go to step 6.

1 Press [Password].

2 Enter a password, and then press [OK].

Note

- If you make a mistake, press **[Clear]** or the **[Clear/Stop]** key and try again.

6 Press [OK].

A box mode is shown next to the box.

Return to the initial display.

Deleting Transfer Boxes

Limitation

- If the specified SUB Code is not programmed as a Transfer Box, or messages are programmed in the box, you cannot delete the box.

Press the **[User Tools/Counter/Inquiry]** key. See p.7 "Control Panel", *Facsimile Reference (option)* <Basic Features>. And then press **[Facsimile Features]** ⇒ **[Key Operator Tools]** ⇒ **[Box Setting]**.

1 Press [Delete] and select a box you want to delete.

Note

- When selecting a file set with a password, the password input screen is displayed. Enter the password using the number keys and press **[OK]**. If you enter an incorrect number, press **[Clear]** to delete the entered numbers. Press **[Cancel]** to cancel file selection.

2 Press **[Delete]**.

The box is deleted and “*Not Programed” is shown.

3 Press **[Exit]**.

Return to the initial display.

Printing the Box List

Follow the procedure below to print a list showing the currently programmed Personal Boxes, Information Boxes and Transfer Boxes.

Press the **[User Tools/Counter/Inquiry]** key. See p.7 “Control Panel”, *Facsimile Reference (option) <Basic Features>*. And then press **[Facsimile Features]** ⇒ **[Key Operator Tools]**.

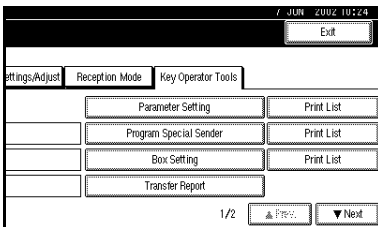
1 Press **[Print List]** next to “Box Setting”.**2** Press the **[Start]** key.

Return to the initial display.

Note

- To cancel printing a list, press **[Cancel]** before pressing the **[Start]** key. The display will return to step **1**.

Transfer Report

For the Requesting Party to be able to receive Transfer Result Reports from the Transfer Station, the Requesting Party must program the number of the telephone line their machine is connected to in their own machine. See p.37 “Transfer Request”.

Be sure to insert a pause after the area code.

For example, if you are in the United States and your fax number is 212-1234567, program the following:

- 1212-1234567

You can program the fax number for each line (G3, G4).

Limitation

- You cannot program or edit Transfer Report when using a line (during communication). Program or edit after communication.

Note

- You cannot use Transfer Request if the telephone number of their machine is not programmed in that machine.
- Up to 16 digits are available for G3.
- Up to 29 digits are available for G4.

Press the **[User Tools/Counter/Inquiry]** key. See p.7 “Control Panel”, *Facsimile Reference (option) <Basic Features>*. And then press **[Facsimile Features]** ⇒ **[Key Operator Tools]** ⇒ **[Transfer Report]**.

- 1 Specify the fax number for each line.

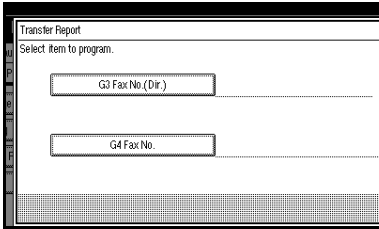

Programming a G3 Fax Number

- 1 Press **[G3 Fax No.(Dir.)]**.
- 2 Enter your facsimile number with the number keys, and press **[OK]**.

Programming a G4 Fax Number

The optional ISDN Unit is required.

- 1 Press **[G4 Fax No.]**.
- 2 Enter your facsimile number with the number keys, and press **[OK]**.
- 2 Press **[Exit]**.
Return to the initial display.

Programming a Confidential ID

Program a Confidential ID to print Confidential Reception. See p.24 “Printing a Confidential Message”.

Note

- If you do not program a Confidential ID, you cannot receive a Confidential Transmission.

Press the **[User Tools/Counter/Inquiry]** key. See p.7 “Control Panel”, *Facsimile Reference (option) <Basic Features>*. And then press **[Facsimile Features]** ⇒ **[Key Operator Tools]** ⇒ **[Program Confidential ID]**.

- 1 Enter an ID with the number keys.

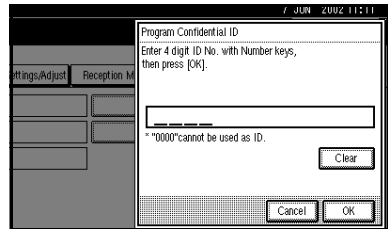

Note

- A Confidential ID can be any 4 digit numeric code except for 0000.
- If you make a mistake, press **[Clear]** or the **[Clear/Stop]** key and try again.

- 2 Press **[OK]**.

Return to the initial display.

Programming a Polling ID

Program a Polling ID to use the Transfer Request, Transfer Station, Default ID Polling Transmission and Default ID Polling Reception. When you use ID Transmission, program the same ID as that programmed on the sender's machine.

🔍 Reference

See p.8 "Polling Transmission".

See p.11 "Polling Reception".

See p.55 "Selecting transmission options for a single transmission".

See p.37 "Transfer Request".

Press the **[User Tools/Counter/Inquiry]** key. See p.7 "Control Panel", *Facsimile Reference (option) <Basic Features>*. And then press **[Facsimile Features]** ⇒ **[Key Operator Tools]** ⇒ **[Program Polling ID]**.

1 Enter an ID with the number keys and [A] to [F].

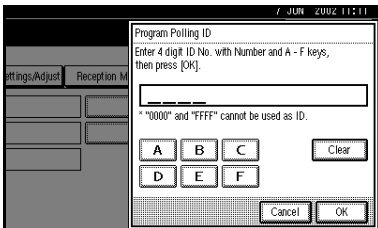

📌 Note

- A Polling ID can be any combination of digits (0-9) and letters (A-F) except for 0000 and FFFF.
- If you make a mistake, press **[Clear]** or the **[Clear/Stop]** key and try again.

2 Press [OK].

Return to the initial display.

Programming a Memory Lock ID

Program a Memory Lock ID to print Memory Lock reception.

A Memory Lock ID can be any 4 digit numeric code except for 0000.

Press the **[User Tools/Counter/Inquiry]** key. See p.7 "Control Panel", *Facsimile Reference (option) <Basic Features>*. And then press **[Facsimile Features]** ⇒ **[Key Operator Tools]** ⇒ **[Program Memory Lock ID]**.

1 Enter an ID with number keys.

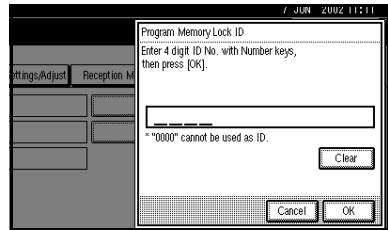

📌 Note

- If you make a mistake, press **[Clear]** or the **[Clear/Stop]** key and try again.

2 Press [OK].

Return to the initial display.

Selecting Dial/Push Phone

Use this function to select a line type when the machine is connected to a G3 analog line.

A Dial and Push line are available for selection.

Note

- "G3-2" is shown on the display, depending on the number of Extra G3 Interface Units installed.
- When the optional G3 expansion unit is installed, "G3-2" is displayed.
- Use the same procedure to program and change this function.
- This function is not available in some areas.

Press the **[User Tools/Counter/Inquiry]** key. See p.7 "Control Panel", *Facsimile Reference (option) <Basic Features>*. And then press **[Facsimile Features]** ⇒ **[Key Operator Tools]** ⇒ **[Select Dial/Push Phone]**.

- 1** Press **[Push Button Phone]** or **[Dial Phone (10PPS)]** to select the line.

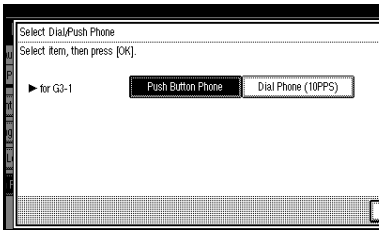

Note

- If you make a mistake, press **[Clear]** or the **[Clear/Stop]** key and try again.

Reference

See p.156 "Selecting the Line Type".

- 2** Press **[OK]**.

Return to the initial display.

Programming ISDN G3 Line

The optional ISDN Unit is required.

This function must be set when you connect the machine to an ISDN G3 digital line.

You can program the following items.

- Own Fax Number 1
- Own Fax Number 2
- Sub-address
See p.39 "Sub-address".

Note

- Program Own Fax Number 1 as your own digital number. Program Own Fax Number 2 as another digital number which occupies a single line.
- You should program the Own Fax Number 1.
- ISDN allows two or more terminals (such as a fax machine and digital telephone) to be connected to a single line. These terminals are identified by their sub-address numbers. If the terminals connected to the line at a destination are assigned sub-addresses, dialing a sub-address allows you to direct your fax message to a particular terminal at the destination.
- Up to 4 digits (0 to 9999) are available for a sub-address.

Press the **[User Tools/Counter/Inquiry]** key. See p.7 “Control Panel”, *Facsimile Reference (option) <Basic Features>*. And then press **[Facsimile Features]** ⇒ **[Key Operator Tools]** ⇒ **[Program ISDN-G3 Line]**.

- 1 Select an item you want to program.

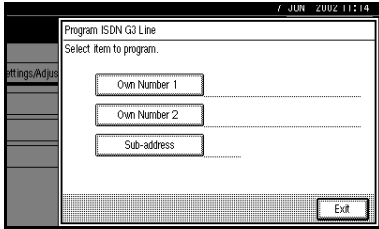

Programming Own Number 1 and Own Number 2

- 1 Select **[Own Number 1]** or **[Own Number 2]**.
- 2 Enter your facsimile number with the number keys, and press **[OK]**.

Programming a Sub-address

- 1 Select **[Sub-address]**.
- 2 Enter a sub-address with the number keys, and press **[OK]**.

- 2 Press **[Exit]**.
Return to the initial display.

Programming ISDN G4 Line

The optional ISDN Unit is required.

This function must be set when you connect the machine to an ISDN G4 digital line.

You can program the following items.

- Own Fax Number 1
- Own Fax Number 2
- Sub-address
See p.39 “Sub-address”.

Note

- Program Own Fax Number 1 as your own digital number. Program Own Fax Number 2 as another digital number which occupies a single line.
- You should program Own Fax Number 1.
- ISDN allows two or more terminals (such as a fax machine and digital telephone) to be connected to a single line. These terminals are identified by their sub-address numbers. If the terminals connected to the line at a destination are assigned sub-addresses, dialing a sub-address allows you to direct your fax message to a particular terminal at the destination.
- Up to 4 digits (0 to 9999) are available for a sub-address.

Press the **[User Tools/Counter/Inquiry]** key. See p.7 “Control Panel”, *Facsimile Reference (option) <Basic Features>*. And then press **[Facsimile Features]** ⇒ **[Key Operator Tools]** ⇒ **[Program ISDN-G4 Line]**.

- 1** Select an item you want to program.

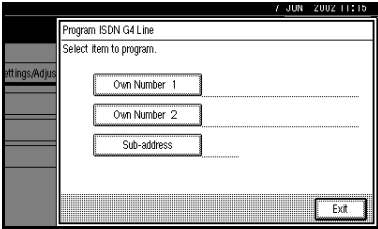

Programming Own Number 1 and Own Number 2

- 1** Select **[Own Number 1]** or **[Own Number 2]**.
- 2** Enter your facsimile number with the number keys, and press **[OK]**.

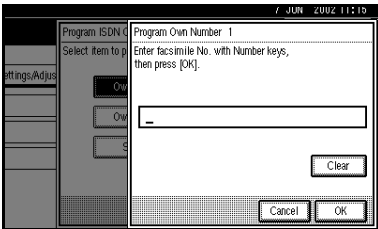

Programming a Sub-address

- 1** Select **[Sub-address]**.

- 2** Enter a sub-address with the number keys, and press **[OK]**.

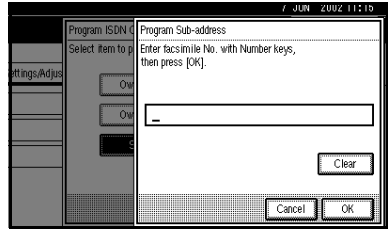

- 2** Press **[Exit]**.
Return to the initial display.

9. LAN FAX Features

Sending Fax Documents from PC

The optional Printer Unit is required to use this feature.

- With a LAN FAX connected to a LAN or Parallel Port, you can use a telephone line to send a fax created using a Windows application to another fax machine.
- To send a fax, simply select **[Print]** from the Windows application, then select LAN FAX as the printer and specify a destination.
- In addition to sending faxes, the LAN FAX driver allows this machine to be used for printing out documents prepared on a PC for proof checking.
- To use the LAN FAX driver, connect this machine to a LAN and make the necessary network settings, and then install the LAN FAX driver and related utilities on your PC.

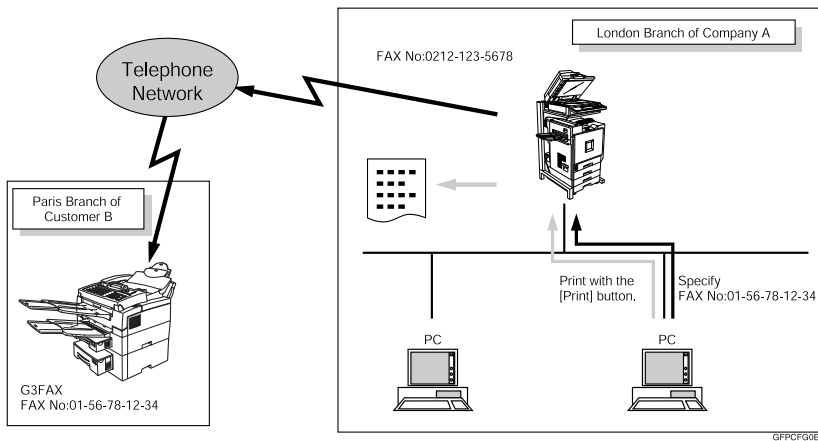

Important

- If errors occur on the machine when used as a LAN FAX, they are not displayed on the PC.

Installing the Software

You need to install the LAN FAX Driver on your computer before using the LAN FAX features. The LAN FAX Driver is on the CD-ROM included with the printer unit.

Note

- The following explanation assumes that you are familiar with general Windows procedures and practices. If you are not, see the documentation that comes with Windows for details.

Auto Run Program

With Windows 95/98/Me, Windows 2000/XP, and Windows NT4.0, the installers for various drivers and utilities launch automatically as Auto Run programs when you insert the CD-ROM.

Note

- If the “plug and play” function starts, click **[Cancel]** in the **[New Hardware Found]**, **[Device Driver Wizard]** or **[Found New Hardware Wizard]** dialog box, and then insert the CD-ROM. The **[New Hardware Found]**, or **[Found New Hardware Wizard]** dialog box appears depending on the system version of Windows 95/98/Me Windows 2000/XP.
- Auto Run might not automatically work with certain OS settings. In this case, launch “Setup.exe” located on the CD-ROM root directory.
- If you want to cancel Auto Run, hold down the **[SHIFT]** key (when your system is Windows 2000/Windows XP, hold down the left **[SHIFT]** key) while inserting the CD-ROM. Keep the **[SHIFT]** key held down until the computer has finished accessing the CD-ROM.
- Clicking **[Cancel]** during the installation of software aborts the installation. If you cancel the installation, restart your computer and install the rest of the software or printer driver you want to install.

The LAN FAX Driver and Address Book can be installed by Auto Run.

◆ Location of the file

The following folders are stored in the CD-ROM:

- LAN FAX Driver for Windows 95/98/Me
 \DRIVERS\LAN-FAX\WIN9X_Me
- LAN FAX Driver for Windows 2000/XP
 \DRIVERS\LAN-FAX\WIN2000
- LAN FAX Driver for Windows NT4.0
 \DRIVERS\LAN-FAX\NT4
- Address Book
 \UTILITY\ADDRESS

❖ Operating Environment

- Computer
PC/AT Compatible
- Operating Systems
Microsoft Windows 95/98/Me
Microsoft Windows 2000/XP
Microsoft Windows NT4.0
- Display
VGA 640×480 dots or more

💡 Limitation

- All operations cannot be guaranteed depending on the system environment.
- When you use Windows NT, the LAN FAX Driver will not work under an RISC base processor (MIPS R series, Alpha AXP, PowerPC) environment.

📖 Note

- To install the driver on Windows 2000/XP or Windows NT4.0, log on using an account that has Administrator permissions.
- Before beginning installation, exit all other applications.

Installing the LAN FAX Driver and the Address Book

📖 Note

- The LAN FAX Driver and Address Book are available when the machine is equipped with Fax Function Upgrade Unit.

1 Quit all running applications.

2 Insert the CD-ROM included with this machine into the CD-ROM drive of your computer.

The installer launches automatically and the Select Language dialog box appears.

📖 Note

- Depending on your operating system settings, the installer may not launch automatically. If it does not, double-click "SETUP.EXE" in the CD-ROM root directory to launch the installer.

3 Select the interface language of the software you are installing, and then click [OK].

The Printer Drivers and Utilities screen appears.

4 Click [LAN-FAX/Address Book].

The Add Printer and Utility wizard launches.

5 Read all of the terms and, if you agree, select the **[I accept the agreement.]** check box and click **[Next]**.

 **Note**

If you select the **[I don't accept the agreement.]** check box, you cannot install the software.

6 Select the **[Address Book]** and **[LAN-Fax Driver]** check boxes, and then click **[Next]**.

The Welcome dialog box appears.

7 Click **[Next]**.

8 Double-click **[Printer Name : <LAN-Fax M2>]**.

9 Click **[Port : <LPT1>]** and then click **[Add]**.

10 Add a port.

 **Reference**

You can check information about the procedure for adding a port with "Printer Drivers and Utilities". See "Installation Method" in the Printer Reference 1.

11 After adding a port, click **[Finish]**.

The Installation Completion dialog box appears.

12 Click **[Finish]**.

Setting LAN FAX Properties

This section describes how to make settings such as document size, resolution, and options.

For details, see the Help file.

Note

- If the options on this machine are not configured as instructed, the function may fail to work as intended.
- If your operating system is Windows 2000/XP or Windows NT4.0, log on using an account that has Administrator permissions.

1 On the [Start] menu, point to [Settings] and then [Printers].

Note

- With Windows XP, select [Printers and Faxes] from the [Start] menu.

2 Click to select "LAN-Fax M2", and then select [Properties] from the [File] menu.

Note

- With Windows NT, select [Document Default] from the [File] menu.

3 Click the [Paper] tab.

Note

- With Windows 2000/XP, click the [Advanced] tab, and then click [Printing Defaults...].

4 Make the paper settings.

Note

- The "Gray Scale" box does not appear in Windows NT or Windows 2000/XP.

◆ Accessories

- ① Click [Accessories...].
- ② Select the appropriate check boxes.

Note

- When the optional Expansion Memory is installed, select the [Memory Extension] check box.
- Be sure to check the [Hard Disk Unit] check box is selected.
- The optional ISDN Unit is required in order to use a G4 line.

! Limitation

- The lines that can be selected when the optional unit has been installed in this machine are:
 - G3-1
 - G3-2
 - G4
- The G3-3 cannot be selected even when the optional unit has been installed in this machine.

- ③ Click [OK].

5 Click [OK].

Basic Transmission

This section describes how to send fax documents created using Windows applications.

To send a fax, simply select [Print] from the Windows application, then select LAN FAX as the printer and specify a destination in the LAN FAX dialog box.

Open the application document you want to send or create a new document, and then perform the following procedure.

For details, see the Help file.

- 1** On the [File] menu, click [Print...].
- 2** Click “LAN-Fax M2” in “Printer Name”, and then click [OK].

Note

- The setting method may differ depending on the application you are using. In all cases, select [LAN-Fax M2] for the printer.

- 3** Specify the destination.

Enter [#] and the registered number when using Quick Dials.

Enter [#] [*] [*] and the registered number when using Group Dials.

Note

- You can specify a destination using the Quick Dials, Group Dials, or Address Book.
- You can directly enter the fax number.
- You can specify up to 100 destinations (200 with the optional Fax Function Upgrade Unit installed and 500 with the optional Expansion Memory installed).

- 4** Specify options.

Reference

See p.142 “Attaching a Cover Sheet”.

See p.142 “Specifying options”.

If you do not want to specify options, go to step **5**.

Attaching a Cover Sheet

- 1** Select the [Attach a Cover Sheet] check box.

Note

- To edit this setting, click [Cover Sheet...]. For details, see the Help file.

Specifying options

You can specify the following options:

For details, see the Help file.

- Sending at Specific Time
See p.5 “Sending at a Specific Time (Send Later)”.
- User Code
See p.9 “Reading the Display Panel and Using Keys”, *Facsimile Reference (option) <Basic Features>*.
- User ID
Required to identify documents. The User ID lets you browse a log of the jobs on SmartNetMonitor for Client.
- Print Fax Header
See p.102 “Fax Header Print Setting”.
- Document Server
See p.84 “Using the Document Server”.

- ❶ Click **[Option...]**.
- ❷ Specify options you want to use.

 **Note**

- The User Code you specified for this machine must be the same as the one entered in this machine. See “User Code” in the General Settings Guide.

- ❸ Click **[OK]**.

- ❹ Click **[Send]**.

 **Note**

- When you click **[Print & Send]**, a fax will be transmitted to the destination and a copy of the document you send will be printed from your machine.
- Click **[Print...]** to print a copy of the document you specified without sending it to the destination.



Transmission result notification

After you have sent faxes from your computer, this function informs your computer whether the fax was successfully transmitted to its destination or not.

When you store documents in the Document Server or use this machine just as a printer, this function also informs your computer whether data was successfully transmitted to this machine or not.

 **Note**

- You cannot refer to any information when using version 5.0 or earlier of SmartNetMonitor for Client.



Printing

You can print documents created using Windows applications.

Open the application document you want to print or create a new document, and then perform the following procedure.

For details, see the Help file.

This function always prints pages in black and white even if a color other than black is specified in “FAX Print Color” or “Reception Mode”.

- ❶ On the **[File]** menu, click **[Print...]**.

- ❷ Click “LAN-Fax M2” in “Printer Name”, and then click **[OK]**.

 **Note**

- The setting method may differ depending on the application you are using. In all cases, select “LAN-Fax M2” for the printer.

- ❸ Click **[Print]**.

Address Book

You can program and edit destinations in the Address List using the Address Book.

For details, see the Help file.

- ❶ On the **[Start]** menu, point to **[Programs]**, and then **[Address Book]**.

- ❷ Edit an existing destination or program a new one.

 **Note**

- You can divide programmed destinations into groups by clicking **[Group...]**. For details, see the Help file.
- For “Line”, select the appropriate line type: G3, G4 or G3-2.

❖ Programming New Destinations

- ① Enter the destination.
- ② Click **[Add]**.

❖ Editing Programmed Destinations

- ① Select the destination you want to edit from the list.
The name of the company should appear in gray.
- ② Edit the data.
- ③ Click **[Update]**.

❖ Deleting Programmed Destinations

- ① Select the destination you want to edit from the list.
The name of the company should appear in gray.
- ② Click **[Delete]**.
- ③ Click **[Yes]**.

3 Click **[Close]**.

4 If you made changes to a destination, a confirmation dialog box appears. To save the changes you made, click **[Yes]**.

If you do not want to save the changes and want to quit editing, click **[No]**.

To return to the editing screen, click **[Cancel]**.

LAN FAX Operation Messages

Message	Causes and Recommended Actions
Cannot access the printer. Click [retry] to send the data again.	Check the network connection. Check that the power of this machine is turned on.
The number of entries in Destinations exceeds the limit. Up to 100 entries can be entered.	The number of destinations specified exceeds the maximum possible. The maximum number of destinations that can be specified at one time is 100 (Up to 200 with optional Fax Function Upgrade Unit, up to 500 with optional Expansion Memory.).
"LAN FAX" has already been launched. Cannot launch it again.	The LAN FAX dialog box is already open. Exit LAN FAX once, then start it up again.
Failed to allocate memory.	Available memory is insufficient.

View Received Messages on a PC

Separately sold ScanRouter V2 Professional is also required as a delivery server. Separately sold DesktopBinder V2 Professional Lite or DesktopBinder V2 Professional software is must be installed on your PC.

Note

- This manual uses the name DesktopBinder V2 Professional/Lite to refer to both DesktopBinder V2 Professional Lite and DesktopBinder V2 Professional.

Delivering Received Messages

Messages received by the machine can be viewed on or downloaded to a PC with the networked delivery server ScanRouter V2 Professional. This is a useful function enabling you to view and store messages on your PC without printing them.

Using the delivery server, you can eliminate the extra work of retrieving received messages from the machine and delivering them to each addressed person.

◆ Functions

Delivery server provides the following functions:

- Use the delivery server to associate incoming messages (Confidential ID, SUB Code, Own Name and Own Fax Number) with receivers so that received messages are delivered to the associated receivers.

- You can choose the delivery method for incoming messages: "Save in the delivery server inbox," "Send as an email attachment," or "Save in the designated PC folder." Incoming messages with no Confidential ID, SUB Code, Own Name or Own Fax Number are saved in the delivery server inbox.
- You can check or download received messages stored in the delivery server inbox using "DesktopBinder V2 Professional Lite" or "DesktopBinder V2 Professional" software.

Limitation

- Confidential messages are also forwarded to the delivery server.

Note

- To view or download messages stored in the inbox of the delivery server, you need to install the included "DesktopBinder V2 Professional Lite" software or the separately sold "DesktopBinder V2 Professional" on your PC.
- To send received messages to your PC as email attachments, you need to have a ScanRouter V2 Professional-compatible email program on your PC.
- To create a network with the delivery server, settings must be specified in the User Tools of the machine. Settings must also be specified on the delivery server. See "Configuring the Network" in General Settings Guide

- ❑ See the instructions or Help on the ScanRouter V2 Professional for more information on the delivery server (ScanRouter V2 Professional).
- ❑ For information on the DesktopBinder V2 Professional/Lite software, see the instructions or Help in DesktopBinder V2 Professional/Lite.

Administering the Fax Information on a PC

Note

- SmartNetMonitor for Client is on the CD-ROM included with this machine.

Administer transmission using the LAN FAX driver

From “SmartNetMonitor for Client”, you can administer transmissions using the LAN FAX driver. You can view the following information on transmitted files using the LAN FAX driver.

- User ID
- Status
- Number of pages
- Start time
- File No.

Reference

For details, see the Help file.

10. Solving Operation Problems

Reading Reports

Error Report

An Error Report is printed when a message could not be successfully sent or received.

Possible causes include a problem with your machine or noise on the telephone line. If an error occurs during transmission, re-send the original. If an error occurs during reception, ask the sender to re-send the message.

Note

- If the error happens frequently, contact your service representative.
- The "Page" column gives the total number of pages. The "Page Not Sent" column gives the number of pages that were not sent or received successfully.

Power Failure Report

CAUTION:

- *When you disconnect the power plug from the wall outlet, always pull the plug (not the cable).*

Even if the main power switch is turned off, the contents of the machine's memory (for example, programmed numbers) will not be lost. However, if power is lost for about 1 hour through the main power switch being turned off, a power cut or the power cable being removed, contents of the Fax memory will be lost. Lost items will include any fax messages stored in memory using Memory Transmission or Reception.

If a file has been deleted from memory, a Power Failure Report is automatically printed as soon as power is restored. This report can be used to identify lost files. If a memory stored for Memory Transmission was lost, re-send it. If a message received by Memory Reception or Substitute Reception was lost, ask the sender to re-send it.

Important

- Do not turn off the main power switch while the power indicator is lit or blinking. If you do, failure and/or damage may cause to the hard disk and the memory.
- Turn off the main power switch before pulling out the plug. If you pull out the plug with the switch on, the hard disk or memory may be damaged. It may also cause complete failure of the hard disk or memory.
- Make sure that 100% is shown on the display before you unplug the machine. If a lower value is shown, some data is currently stored in memory.
- Right after a power failure, the internal battery needs to be sufficiently recharged to guard against future data loss. Please keep the machine plugged in and the main power switch on for about one week after the power loss occurs.

 **RDS (Remote Diagnostic System)**

If your machine has a problem, a service representative can perform various diagnostic tasks over the telephone line from the service station to try to find out what is wrong with your machine. The service representative can also use RDS to change some of your machine's settings if you request it.

If you wish to use this function, change the User Parameter. See p.113 "Changing the User Parameters" (Switch25, Bit4).



When Toner Runs Out

When the machine has run out of toner the symbol appears on the display. Note that even if there is no toner left, you can still send fax messages.

Important

- ❑ If you continue receiving and sending faxes after toner runs out, communication will not be possible after 200 communications (1,000 with the optional Expansion Memory).

Note

- ❑ The Memory Storage Report, Polling Reserve Report and Confidential File Report are not printed.

- 1 Make sure that the machine is in Facsimile mode and the standby display is shown.

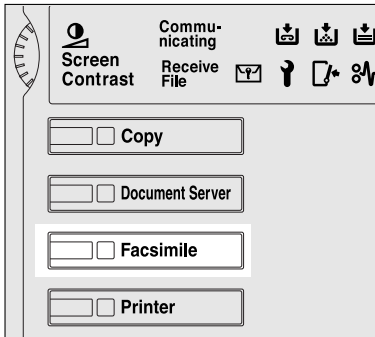

Note

- ❑ If the standby display is not shown, press the **[Facsimile]** key.

- 2 Press **[Exit]**.

The error display closes.

Reference

See p.19 “Memory Transmission”, *Facsimile Reference (option)* <Basic Features>.

See p.24 “Immediate Transmission”, *Facsimile Reference (option)* <Basic Features>.

10

11. Appendix

Replacing the Stamp Cartridge

The optional Document Feeder (ADF) is required.

When the stamp becomes lighter, replace the cartridge.

Note

- Use the cartridge specified for this machine.

- 1** Lift the optional Document Feeder (ADF).

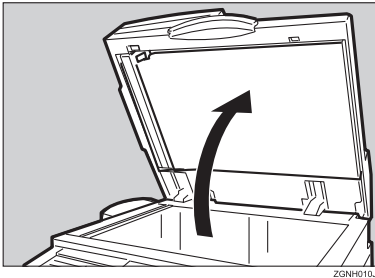

- 2** Open the stamp cover.

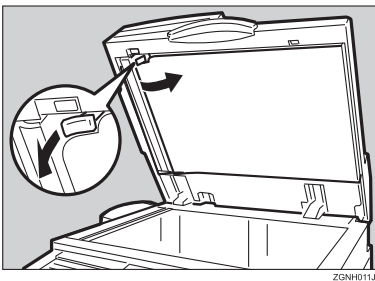

- 3** Pull out the cartridge.

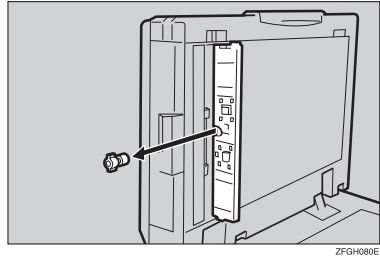

- 4** Set a new cartridge while holding down the lock lever.

Insert the cartridge until its metal parts are not visible.

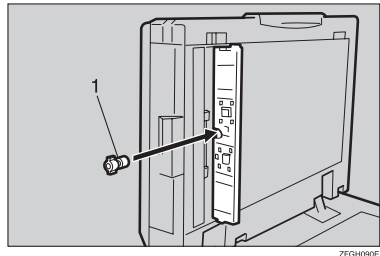

- 1.** New Cartridge

- 5** Replace the stamp cover until it clicks.

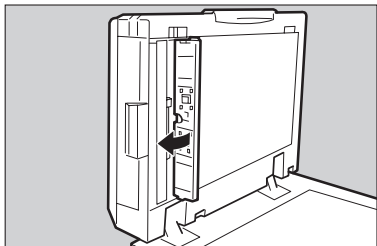

ZFGH100E

- 6** Close the optional Document Feeder (ADF).

Connecting the Machine to a Telephone Line and Telephone

Connecting the Telephone Line

To connect the machine to a telephone line, use a snap-in modular type connector.

Important

Make sure the connector is the correct type before you start.

◆ Where to connect the machine

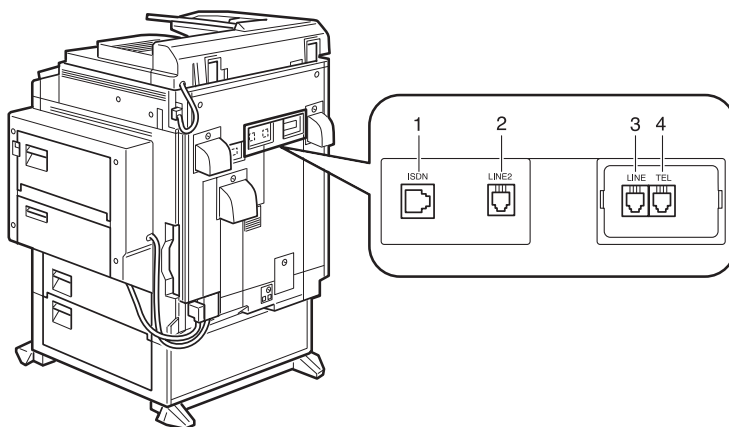

ZFLH040E

1. G4 Interface Unit Connector

3. G3 Interface Unit Connector

2. Extra G3 Interface Unit Connector

4. External Telephone Connector

Important

Do not connect the G3 line into the G4 Interface Unit Connector.

Connecting the Machine to ISDN

The optional ISDN Unit is required.

For details about how to install the optional ISDN Unit, please contact your service representative.

Connect the machine to the ISDN with a modular type connector.

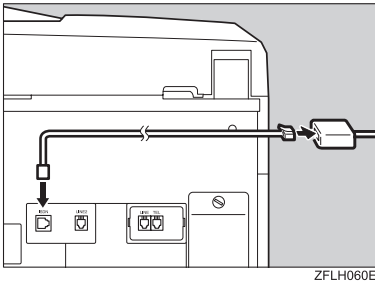

Selecting the Line Type

Select the line type to which the machine is connected. There are two types: tone and pulse dial.

Select the line type using in "Key Operator Settings". See p.134 "Selecting Dial/ Push Phone".

Multi-port

When the optional ISDN Unit or optional Extra G3 Interface Unit is installed, communications can take place simultaneously through two lines at once.

Option	Available Line Types	Available Protocol Combinations
Without option	PSTN	G3
Extra G3 Interface Unit	PSTN+PSTN	G3+G3
ISDN Unit	PSTN+ISDN	G3+G4 or G3 (ISDN)+G4
	ISDN	G3 (ISDN)+G4
Extra G3 Interface Unit+G4 Interface Unit	PSTN+PSTN+ISDN	G3+G3+G4 or G3 (ISDN)+G4
	PSTN+ISDN	G3+G3(ISDN)+G4 or G3 (ISDN)+G3(ISDN)

Note

- A maximum of three communications can take place simultaneously.
- You cannot perform three Immediate Transmissions simultaneously.
- If three fax messages are received simultaneously, they cannot be printed out at the same time.
- If three communications are in progress, the display shows the first communication that was initiated.

Optional Equipment

Fax Function Upgrade Unit

JBIG compression for transmission/reception becomes possible.

You can increase the maximum programmable numbers of the following functions. See p.163 "Maximum Values".

- Quick Dial
- Memory Transmission file
- Auto Document
- Specific Sender
- Program
- Transmission Result

Expansion Memory (32MB: DIMM)

This allows you to send and receive fax messages at high resolution (Fine or Super Fine). If you need this option, please consult your service representative. See p.163 "Maximum Values".

ISDN Unit

This allows you to send and receive messages via ISDN (Integrated Service Digital Network).

You can use the following functions.

Function	Reference
Sub-address	See p.39 "Sub-address".
UUI	See ⇒ p.40 "UUI".

Extra G3 Interface Unit

This option provides one Extra G3 line connection.

Specifications

Standard	G3, G4 (option)
Resolution	G3: 8×3.85/mm•200×100dpi (Standard), 8×7.7/mm•200×200dpi (Detail), 8×15.4/mm•200×400dpi (Fine), 16×15.4/mm•400×400dpi (Super Fine: optional Expansion Memory required) G4: 200×100dpi (Standard), 200×200dpi (Detail), 400×400dpi (Super Fine: optional Expansion Mem- ory required)
Transmission Time	G3: 3 seconds at 28,800bps, Standard resolution G4: 3 seconds, Detail resolution
Data Compression Method	MH, MR, MMR, JBIG (optional Fax Function Up- grade Unit required)
Maximum Original Size	Standard size: A3, 11"×17" Irregular size: 304×432mm
Maximum Scanning Size	297×1,200mm/11"×47"
Print Process	Printing on standard paper using a laser
Transmission Speed	G3: 33,600/31,200/28,800/26,400/24,000/21,600/19,2 00/16,800/14,400/12,000/9,600/7,200/4,800/2,40 0bps (auto shift down system) G4: 64/56kbps (auto speed matching) I G3: Max 26,400bps









❖ Power Consumption

Standby Mode	200W
Transmission	200W
Reception	200W
Maximum Power Consumption	1,500W
Auto Off Mode	40W or less

Acceptable Types of Originals

Make sure your originals are completely dry before setting them in the machine. Originals containing wet ink or correcting fluid will mark the exposure glass and the resulting image will be affected.

Acceptable Original Sizes

Where Original is Set	Acceptable Original Size	Maximum Number of Sheets	Paper Thickness
Exposure Glass	Maximum A3 (297×420mm), 11"×17" (279×432mm)	1	----
Optional Document Feeder (ADF), single-sided document	Fax transmission: A5  to A3  (up to 1,200mm long) 8"×5 1/2"  to 11"×17" 	50 sheets (80g/m ² , 20lb)	40 -128g/m ² (11-34lb)
Optional Document Feeder (ADF), double-sided document	Fax transmission: A5  to A3  (up to 432mm long) 8"×5 1/2"  to 11"×17" 	50 sheets (80g/m ² , 20lb)	52-105g/m ² (14-28lb)

Paper Size and Scanned Area

◆ Exposure Glass

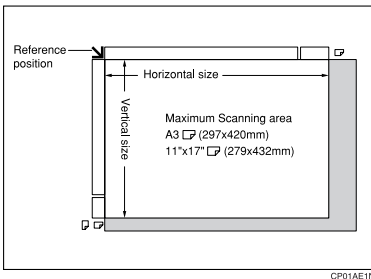

◆ Optional Document Feeder (ADF)

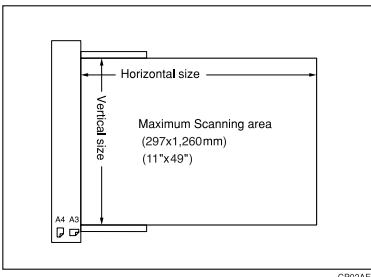

Limitation

- There may be a difference in the size of the image when it is printed at the destination.
- If you place an original larger than A3, 11"×17" on the exposure glass, only an are a of A3, 11"×17" is scanned.

Note

- Even if an original is correctly placed on the exposure glass or in the optional Document Feeder (ADF), a margin of 3mm (0.1") around each edge of the original may not be sent.
- If the receiver uses paper of smaller width than the original, the image will be reduced to fit the paper. See p.54 "Auto Reduce".
- The machine detects paper sizes in the following ways:
 - When you place an original in the optional Document Feeder (ADF), an original wider than about 268mm (10.5") is scanned as A3, 11"×17" size. An original narrower than about 235mm (9.2") will be sent as 8¹/₂"×11" or 8¹/₂"×14" size. Originals up to 1,260mm (49") in length can be scanned.

- Refer to the table below for the sizes the machine can detect when you place an original on the exposure glass. Because the machine scans in non-standard size documents as one of the standard sizes, parts of the image may be truncated depending on the length of the document. For details about how to set non-standard size documents. See p.16 "Setting a Scan Area", *Facsimile Reference (option) <Basic Features>*.

Metric Version

		Length ^{*1}			
		~245mm	245mm~270mm	270mm~318mm	318mm~
Width	~242mm	×	B5	A4	8 ¹ / ₂ "×13"
	242mm~272mm	B5	×	×	B4
	272mm~	A4	×	×	A3

Inch Version

		Length ^{*1}			
		~9.6"	9.6"~10.6"	10.6"~12.5"	12.5"~
Width	~9.5"	×	×	8 ¹ / ₂ "×11"	8 ¹ / ₂ "×14"
	9.5"~10.7"	×	×	×	×
	10.7"~	8 ¹ / ₂ "×11"	×	×	11"×17"

× - Unable to auto detect

^{*1} Normally a length of about 420mm (16.5") can be scanned, however, it is only possible to specify a scanning size up to 432mm (17").

 **Maximum scan area**

The Maximum Scan Area is shown below.

- Memory Transmission: 297×1,260mm/11"×49" (W×L) from the optional Document Feeder (ADF)
- Immediate Transmission: 297×1,260mm/11"×49" (W×L) from the optional Document Feeder (ADF)

 **Note**

- During Immediate Transmission, the length of the scanning range can become narrower than 1,260 mm (49"), depending on the character size as well as the settings on the destination machine.
 - 297×432mm/11"×17" (W×L) (From the exposure glass)
- 

Maximum Values

The following list contains the maximum value for each item.

Item	Standard	With optional unit		
		Fax Function Upgrade Unit	Expansion Memory	Expansion Memory + Fax Function Upgrade Unit
Memory	2MB	2MB	26MB	26MB
The number of pages that you can store in memory (Using A4 size Standard <ITU-T #1Chart>)	160	160	1,000	2,080
Total number of all files *2	400	800	400	800
The number of pages per file	400	400	1,000	1,000
The number of pages for all files	400	400	1,000	3,000
The number of destinations you can specify for one file	500	500	500	500
The number of destinations you can specify for all files	500	2,000	500	2,000
The number of Quick Dials you can register	400	1,200	400	1,200
The number of Group Dials you can register	64	64	64	64
The number of destinations you can specify by the number keys	100	1,000	100	1,000
The number of destinations you can register in a group *1	500	500	500	500
The number of destinations you can register in all groups *1	500	2,200	500	2,200
The number of digits for Dials	254	254	254	254
The number of Programs you can register	100	200	100	200

Item	Standard	With optional unit		
		Fax Function Upgrade Unit	Expansion Memory	Expansion Memory + Fax Function Upgrade Unit
The number of Auto Documents you can register	6	18	6	18
The number of Standard Message Stamps you can register	3	3	3	3
The number of transmission results the machine can store	200	1,000	200	1,000
The number of stored documents you can specify at one time	400	400	1,000	1,000
The number of stored documents you can send at one time	30	30	30	30
The number of pages that you can store in Document Server (Using ITU-T #4Chart)	2000	2,000	2,000	2,000
The number of pages you can store in Document Server for one document	400	400	1,000	1,000

*1 You can register 400 destinations in the Quick Dials and 100 destinations in the number keys as a Group. When the optional Fax Function Upgrade Unit is installed: 1,200 destinations in the Quick Dials/1,000 destinations in the number keys.

*2 The number of documents you can store varies when capture settings are made.

INDEX

180 Degree Rotation Printing, 72
2-Sided Printing, 64, 71
2-Sided Transmission, 46

A

Acceptable Types of Originals, 160
Accessories, 141
Address Book, 143
Attaching a Cover Sheet, 142
Authorized Reception, 118
Auto Document, 47, 97
 Changing, 97
 Deleting, 99
 Sending, 47
 Storing, 97
Auto Fax Reception Power-up, 69
Auto Identification, 44
Automatic Redial, 58
Auto Reduce, 54

B

Basic Transmission, 142
Batch Transmission, 58
Book Fax, 45
Box Setting, 107, 124
Broadcasting Sequence, 59

C

Canceling
 Transmission, 14
 Transmission Files, 13
Center Mark, 70
Chain Dial, 33
Changing
 Line Type, 43
 Transmission Time, 16
Checkered Mark, 70
Checking
 Reception Result (RX File Status), 22
 Transmission Files, 13
 Transmission Result (TX File Status), 21
CIL, 75
CIL/TID Print, 75
Combine 2 originals, 63, 73
Communication Failure Report, 61
Communication Information, 19
Confidential File Report, 25
Confidential ID, 132
Confidential Message, 24
Confidential Transmission, 7
Counters, 107, 109
CSI→Own Fax Number, 66

D

Default ID/Free Polling Reception, 11
Default ID Transmission, 8, 55
Default ID TX, 9
Deleting
 Information Box Messages, 31
 Programmed Destinations, 144
Destination
 Adding, 15
 Checking, 13
 Deleting, 14
Displaying the Memory Status, 23
Document Server, 84
 Delete File, 88
 File Manage, 87
 Storing a Document, 85
Dual Access, 59

E

ECM (Error Correction Mode), 58, 107, 112
Economy Transmission Time, 5
Editing Programmed Destinations, 144
End Receiver, 38, 67
Error Report, 149
Expansion Memory, 158
Extra G3 Interface Unit, 158

F

Fax Function Upgrade Unit, 158
Fax Header Print, 53
File
 Printing, 17
 Printing a List of Files in Memory
 (*Print TX File List*), 18
 Re-sending, 17
Forwarding, 107, 109, 118
Forwarding Station, 110
Free Polling Transmission, 8
Free Polling TX, 9
Full/Partial agreement, 117
Function List, 107

G

G3/G4 Separate Tray, 79
General Settings/Adjustment, 92, 102

H

Handy Dialing Functions, 33

I

ID Override Polling Reception, 11
ID Override Transmission, 9
Image Rotation, 59, 72
Immediate Reception, 63
Information Boxes, 29, 126, 128
 Deleting, 128
 Printing, 131
 Programming/Editing, 126
 Storing Messages, 29
ISDN, 156
 ISDN G3 Line, 134
 ISDN G4 Line, 135
 ISDN Unit, 158

J

JBIG, 60, 69
 Reception, 69
 Transmission, 60
Journal, 19
"Just Size" Printing, 77

K

Key Operator Code, 93
Key Operator Settings, 107
Key Operator Tools, 92
Keystroke Program, 81

L

Label Insertion, 54
Line Type, 43, 156

M

Manual Dial, 42
Maximum Value, 163
Memory Lock, 26, 111, 119
Memory Lock ID, 133
Memory Lock RX, 107
Memory Reception, 63
Memory Status, 23
Memory Storage Report, 61
More Transmission Functions, 57
Multi-copy, 64
Multi-copy Reception, 72
Multi-port, 157
Multistep Transfer, 68

O

On Hook Dial, 41
Optional Equipment, 158
Originals, 160
Output Tray, 79

P

- Page Reduction, 74
- Page Separation and Length Reduction, 73
- Paper Tray, 104
- Parallel Memory Transmission, 57
- Parameter Setting, 107
- PC FAX Features, 137
- PC FAX Operation Messages, 144
- PC FAX Properties, Setting, 141
- Personal Boxes, 27, 124, 126
 - Deleting*, 126
 - Editing*, 124
 - Printing*, 131
 - Programming*, 124
- Polling ID, 133
- Polling Reception, 11
- Polling Reserve Report, 12
- Polling Result Report, 12
- Polling Transmission, 8
- Polling Transmission Clear Report, 10
- Power Failure Report, 149
- Print 2 Sided, 119
- Print Completion Beep, 70
- Printed Report, 61
- Printing, 143
 - Box List*, 131
 - Confidential Message*, 24
 - File Received with Memory Lock*, 26
 - Information Box Messages*, 30
 - Journal*, 19
 - Options*, 70
 - Personal Box Messages*, 28
 - Special Sender List*, 124
- Printing the Journal, 19
- Print List/Report, 92
- Prog./Change/Delete, 92
- Program/Change/Delete Menu, 94
- Programming
 - ISDN-G3 Line*, 134
 - ISDN-G4 Line*, 135
- Programming New Destinations, 144
- Programs, 81
 - Changing*, 81
 - Deleting*, 83
 - Registering*, 81
- PWD Code, 37

Q

- Quick Dial Table, 94
 - Changing the Order*, 94
 - Programming Title*, 95

R

- RDS (Remote Diagnostic System), 150
- Reception, 63
 - Reception Features*, 63
 - Reception File Print Quantity*, 119
 - Reception Functions*, 67
 - Reception Mode*, 92, 104
 - Reception Reverse Printing*, 119
 - Reception Time*, 71
- Redial, 33
- Reduced Image Transmission, 54
- Report, 61, 149
 - Communication Failure Report*, 61
 - Error Report*, 149
 - Memory Storage Report*, 61
 - Power Failure Report*, 149
 - Transmission Result Report (Immediate Transmission)*, 62
 - Transmission Result Report (Memory Transmission)*, 61
- Reports/Lists, 101
- Requesting Party, 38, 67
- Reverse Order Printing, 64, 74
- RTI→Own Name, 66
- RX File Status, 22

S

- Scan Size, 99
 - Changing*, 99
 - Deleting*, 100
 - Programming*, 99
- Selecting
 - Dial/Push Phone*, 134
 - Line Type*, 156
- Sender Stamp, 54
- Sending at a Specific Time (Send Later), 5
- Send Later, 5
- SEP Code, 36
- SID Code, 36
- Simultaneous Broadcast, 59
- Solving Operation Problems, 149
- Special Senders, 117
- Special Senders to Treat Differently, 117
- Specifications, 159
- Specifying Options, 142
- Stamp, 53
- Stamp Cartridge, 153
- Standard Messages, 96
 - Deleting*, 97
 - Programming*, 96
- Standard Message Stamp, 47
- Sub-address, 39
- SUB Code, 35
- Substitute Reception, 64
- Switches and Bits, 113
- Switching Titles, 96

T

- Telephone Line, 155
- TID, 75
- Toner, 151
- Transfer Boxes, 128, 130
 - Deleting*, 130
 - Printing*, 131
- Transfer Report, 131
- Transfer Request, 37
- Transfer Result Report, 68
- Transfer Station, 38, 67
- Transmission Features, 33
- Transmission Mode, 5
- Transmission Options, 53
- Transmission Result Report
 - (Immediate Transmission), 62
- Transmission Result Report
 - (Memory Transmission), 61
- Transmission with Image Rotation, 59
- Tray Shift, 79
- TSI Print, 75
- TX File, 13
- TX File Status, 21

U

- User Parameter List, 113
- User Parameters, 113
- User Tools, 92
- UUI, 40

MEMO

MEMO

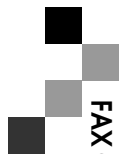

FAX Option Type 1232 Operating Instructions Facsimile Reference (option) <Advanced Features>



B5028658A

Printed in Japan

AE **AE** B502-8658A